

Programmable Controller

Industrial PC

# CC-Link IE Field Network Basic Reference Manual

---

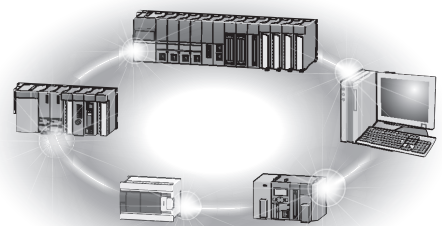



# SAFETY PRECAUTIONS

---

(Read these precautions before using Mitsubishi Electric programmable controllers.)

Before using Mitsubishi Electric programmable controllers and Industrial PC, please read the manuals for the products used and the relevant manuals carefully and pay full attention to safety to handle the products correctly.

Make sure that the end users read this manual and then keep the manual in a safe place for future reference.

## CONDITIONS OF USE FOR THE PRODUCT

---

(1) Mitsubishi programmable controller and industrial PC ("the PRODUCT") shall be used in conditions;

- i) where any problem, fault or failure occurring in the PRODUCT, if any, shall not lead to any major or serious accident; and
- ii) where the backup and fail-safe function are systematically or automatically provided outside of the PRODUCT for the case of any problem, fault or failure occurring in the PRODUCT.

(2) The PRODUCT has been designed and manufactured for the purpose of being used in general industries.

MITSUBISHI SHALL HAVE NO RESPONSIBILITY OR LIABILITY (INCLUDING, BUT NOT LIMITED TO ANY AND ALL RESPONSIBILITY OR LIABILITY BASED ON CONTRACT, WARRANTY, TORT, PRODUCT LIABILITY) FOR ANY INJURY OR DEATH TO PERSONS OR LOSS OR DAMAGE TO PROPERTY CAUSED BY the PRODUCT THAT ARE OPERATED OR USED IN APPLICATION NOT INTENDED OR EXCLUDED BY INSTRUCTIONS, PRECAUTIONS, OR WARNING CONTAINED IN MITSUBISHI'S USER, INSTRUCTION AND/OR SAFETY MANUALS, TECHNICAL BULLETINS AND GUIDELINES FOR the PRODUCT.

("Prohibited Application")

Prohibited Applications include, but not limited to, the use of the PRODUCT in;

- Nuclear Power Plants and any other power plants operated by Power companies, and/or any other cases in which the public could be affected if any problem or fault occurs in the PRODUCT.
- Railway companies or Public service purposes, and/or any other cases in which establishment of a special quality assurance system is required by the Purchaser or End User.
- Aircraft or Aerospace, Medical applications, Train equipment, transport equipment such as Elevator and Escalator, Incineration and Fuel devices, Vehicles, Manned transportation, Equipment for Recreation and Amusement, and Safety devices, handling of Nuclear or Hazardous Materials or Chemicals, Mining and Drilling, and/or other applications where there is a significant risk of injury to the public or property.

Notwithstanding the above, restrictions Mitsubishi may in its sole discretion, authorize use of the PRODUCT in one or more of the Prohibited Applications, provided that the usage of the PRODUCT is limited only for the specific applications agreed to by Mitsubishi and provided further that no special quality assurance or fail-safe, redundant or other safety features which exceed the general specifications of the PRODUCTS are required. For details, please contact the Mitsubishi representative in your region.

## INTRODUCTION

---

Thank you for purchasing the Mitsubishi Electric programmable controllers and Industrial PC.

This manual describes the specifications, procedures before operation, system configuration, functions, and troubleshooting of CC-Link IE Field Network Basic.

Before using the products, please read this manual carefully and develop familiarity with CC-Link IE Field Network Basic to handle the products correctly.

When applying the program and circuit examples provided in this manual to an actual system, ensure the applicability and confirm that it will not cause system control problems.

Please make sure that the end users read this manual.

### Point

In this manual, special relay (SM)/special register (SD) numbers and buffer memory addresses are described using those of the MELSEC iQ-R series. When a different series is used, refer to the following.

 Page 58 List of SM/SD/Buffer Memory Areas for CC-Link IE Field Network Basic

---

# CONTENTS

SAFETY PRECAUTIONS .....	1
CONDITIONS OF USE FOR THE PRODUCT .....	1
INTRODUCTION.....	1
TERMS .....	4
<b>CHAPTER 1 OVERVIEW</b> .....	<b>5</b>
1.1 Features .....	6
<b>CHAPTER 2 SPECIFICATIONS</b> .....	<b>8</b>
2.1 Performance Specifications .....	8
<b>CHAPTER 3 FUNCTION LIST</b> .....	<b>11</b>
<b>CHAPTER 4 PROCEDURES BEFORE OPERATION</b> .....	<b>13</b>
<b>CHAPTER 5 SYSTEM CONFIGURATION</b> .....	<b>15</b>
5.1 CC-Link IE Field Network Basic System Configuration .....	15
Access range .....	16
Number of link points .....	17
5.2 Product List .....	18
Modules and devices can be used as the master station .....	18
Modules and devices can be used as a slave station .....	19
Wiring products .....	19
<b>CHAPTER 6 PROGRAMMING</b> .....	<b>20</b>
6.1 Interlock Programs of Cyclic Transmission .....	20
Program using labels .....	20
Program using devices .....	22
<b>CHAPTER 7 FUNCTIONS</b> .....	<b>23</b>
7.1 Cyclic Transmission .....	23
Data flow and link device assignment .....	23
Link refresh .....	27
Operation of the link scan .....	29
Group number setting .....	31
Input and output status when failure occurs .....	33
Output status for CPU STOP .....	33
7.2 Reserved Station Specification .....	34
<b>CHAPTER 8 PARAMETER SETTINGS</b> .....	<b>35</b>
8.1 Settings for MELSEC iQ-R/MELSEC iQ-L/MELSEC iQ-F .....	35
CC-Link IEF Basic settings .....	35
8.2 Settings for MELSEC-Q/MELSEC-L .....	43
CC-Link IEF Basic settings .....	43
8.3 Settings for MELIPC .....	45
<b>CHAPTER 9 TROUBLESHOOTING</b> .....	<b>46</b>
9.1 CC-Link IE Field Network Basic Diagnostics .....	46

<b>9.2</b>	<b>Troubleshooting by Symptom</b> .....	<b>49</b>
<b>9.3</b>	<b>Acquiring diagnostic information of slave stations</b> .....	<b>52</b>
	How to acquire diagnostic information .....	52
	Program for acquiring diagnostic information .....	52
 <b>APPENDICES</b>		<b>58</b>
<hr/>		
<b>Appendix 1</b>	<b>List of SM/SD/Buffer Memory Areas for CC-Link IE Field Network Basic</b> .....	<b>58</b>
<b>Appendix 2</b>	<b>Processing Time</b> .....	<b>61</b>
	Link scan time .....	62
	Transmission delay time .....	63
<b>Appendix 3</b>	<b>Added and Enhanced Functions</b> .....	<b>64</b>
 <b>INDEX</b>		<b>66</b>
<hr/>		
REVISIONS	.....	68
WARRANTY	.....	69
TRADEMARKS	.....	70

# TERMS

Unless otherwise specified, this manual uses the following terms.

Term	Description
Buffer memory	Memory in a module for storing data such as setting values and monitored values
Cyclic transmission	A function by which data are periodically exchanged among stations on the same network using link devices on CC-Link IE Field Network Basic
Disconnection	A process of stopping data link if a data link error occurs
Label	A label that represents a device in a given character string
Link device	A device (RX, RY, RWr, or RWw) in a CPU module and a MELIPC for the purpose of communicating with slave stations.
Link refresh	Automatic data transfer between a user device and a link device
Link scan (link scan time)	The master station of CC-Link IE Field Network Basic sends requests to all slave stations. After receiving responses from all the slave stations, the master station sends next requests. The time taken from when requests are sent to when the next requests are started to send by the master station.
Master station	A station that controls the entire CC-Link IE Field Network Basic. Only one master station can be used in a network.
MELIPC	An abbreviation for Mitsubishi Electric Industrial PC, MI5122-VW.
RAS	An abbreviation for Reliability, Availability, and Serviceability. This term refers to usability of automated equipment.
Reference response time	The time taken from when a slave station of CC-Link IE Field Network Basic has received a request from the master station to when the slave station send a response to the master station.
Reserved station	A station reserved for future use. This station is not actually connected on CC-Link IE Field Network Basic, but counted as a connected station
Return	A process of restarting data link when a station recovers from an error
Slave station	A station that performs cyclic transmission with the master station on CC-Link IE Field Network Basic. I/O signals in units of bits and I/O data in units of words are exchanged.
SLMP	An abbreviation for Seamless Message Protocol. This protocol is used to access an SLMP-compatible device or a programmable controller connected to an SLMP-compatible device from an external device.
Subnet mask	A number used to logically divide one network into multiple subnetworks and manage them easily. The following Ethernet network systems can be configured: <ul style="list-style-type: none"> <li>• A small-scale Ethernet network system in which multiple network devices are connected</li> <li>• A medium- or large-scale network system in which multiple small-scale network systems are connected via routers or other network communication devices</li> </ul>
User device	A device (X, Y, M, D, or others) in a CPU module and a MELIPC.

# 1 OVERVIEW

CC-Link IE Field Network Basic is an factory automation network using the standard Ethernet.

Data is periodically communicated between the master station and slave stations using link devices (cyclic transmission).

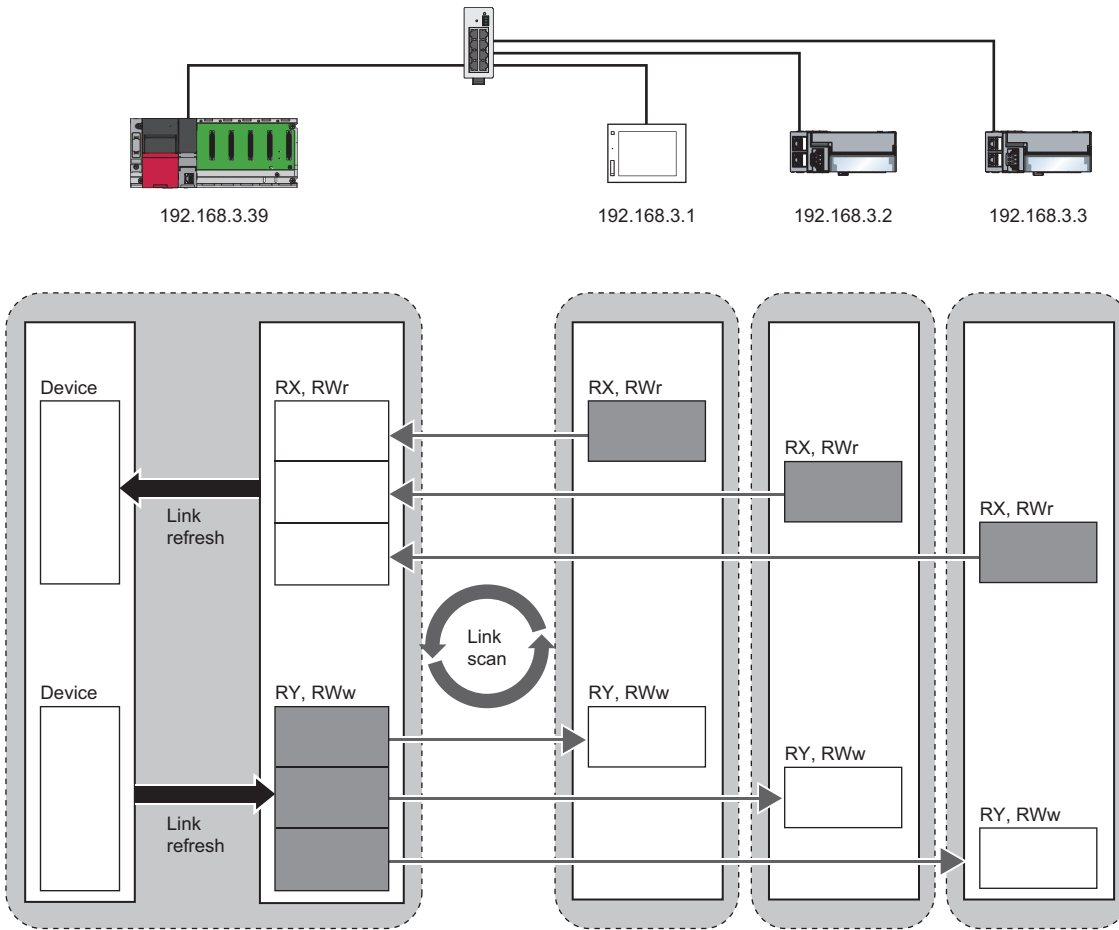

For details on cyclic transmission, refer to the following.

📄 Page 23 Cyclic Transmission

# 1.1 Features

## Cost saving of the system

The CPU module with built-in Ethernet port or the MELIPC can be used as the master station of CC-Link IE Field Network Basic. Since a dedicated network module is not used, the cost for the system can be reduced.

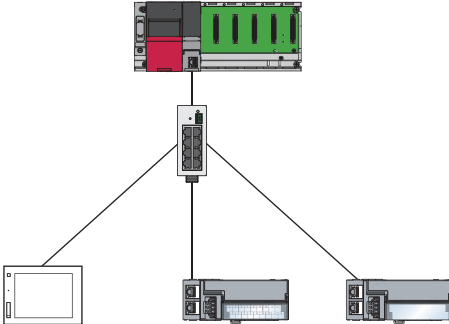

## Using different protocols

CC-Link IE Field Network Basic can be used with other standard Ethernet protocols. Thus, a network system in which different protocols such as FTP, HTTP, and SLMP coexist can be configured.

Moreover, a gateway is not required for communications with personal computers and other information devices.

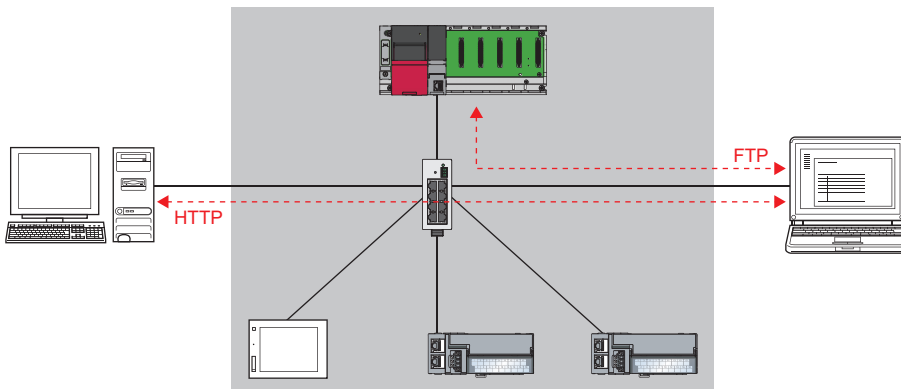

### Point

The link scan time of cyclic transmission is increased by executing following functions:

- The built-in Ethernet functions such as FTP, socket communications, and SLMP communications
- Communications with other Ethernet devices on the same line

Use the built-in Ethernet function above or other Ethernet devices so that the system being used is not affected. (☞ Page 51 When access to the CPU module is slow)



## Easy system configuration

Configure the entire network of CC-Link IE Field Network Basic in the master station. To perform the cyclic transmission, set an IP address and subnet mask to each slave station. Setting the information of the master station to each slave station is not required.

In addition, since the devices are connected in star topology, there are no restrictions on the connection order or connection position of devices. Thus, it is also easy to connect a new slave station.

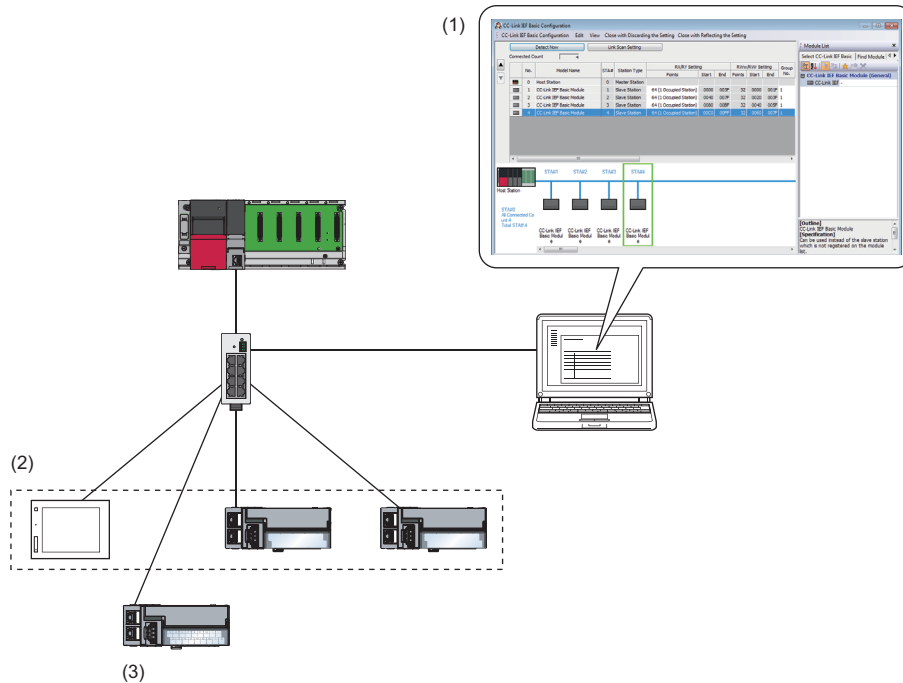

- (1) Configure the entire network of CC-Link IE Field Network Basic in the master station.
- (2) Set the IP address and subnet mask.
- (3) There are no restrictions on the connection order or connection position when a new slave station is added on the same network. Changing the setting for existing slave stations is not required.



CC-Link IE Field Network Basic does not require setting of the connection with the slave station.

# 2 SPECIFICATIONS

This chapter describes the specifications of CC-Link IE Field Network Basic.

## 2.1 Performance Specifications

The following table lists the performance specifications of CC-Link IE Field Network Basic.

For the performance specifications of CC-Link IE Field Network Basic with the MELIPC, refer to the following.

 MELIPC MI5000 Series User's Manual (Startup)

Item		Specifications					
		MELSEC iQ-R <sup>*2</sup>	MELSEC iQ-L	MELSEC iQ-F <sup>*3</sup>	MELSEC-Q <sup>*4</sup>	MELSEC-L <sup>*4</sup>	
Number of connectable modules per network	Master station	1					
	Slave station <sup>*1</sup>	64 (16 × 4 groups)	64 (16 × 4 groups)	FX5UJ: 8 FX5U, FX5UC: 16 FX5-ENET: 32	64 (16 × 4 groups)	16	
Number of stations occupied by a slave station		1 to 4					
Maximum number of link points per network	RX	4096	4096	FX5UJ: 512 FX5U, FX5UC: 1024 FX5-ENET: 2048	4096	1024	
	RY	4096	4096	FX5UJ: 512 FX5U, FX5UC: 1024 FX5-ENET: 2048	4096	1024	
	RWr	2048	2048	FX5UJ: 256 FX5U, FX5UC: 512 FX5-ENET: 1024	2048	512	
	RWw	2048	2048	FX5UJ: 256 FX5U, FX5UC: 512 FX5-ENET: 1024	2048	512	
Maximum number of link points per station	Master station	RX	4096	4096	FX5UJ: 512 FX5U, FX5UC: 1024 FX5-ENET: 2048	4096	1024
		RY	4096	4096	FX5UJ: 512 FX5U, FX5UC: 1024 FX5-ENET: 2048	4096	1024
		RWr	2048	2048	FX5UJ: 256 FX5U, FX5UC: 512 FX5-ENET: 1024	2048	512
		RWw	2048	2048	FX5UJ: 256 FX5U, FX5UC: 512 FX5-ENET: 1024	2048	512
	Slave station	RX	64 (1 station occupied) 128 (2 station occupied) 192 (3 station occupied) 256 (4 station occupied)				
		RY	64 (1 station occupied) 128 (2 station occupied) 192 (3 station occupied) 256 (4 station occupied)				
		RWr	32 (1 station occupied) 64 (2 station occupied) 96 (3 station occupied) 128 (4 station occupied)				
		RWw	32 (1 station occupied) 64 (2 station occupied) 96 (3 station occupied) 128 (4 station occupied)				
UDP port number used in the cyclic transmission		61450					

Item	Specifications				
	MELSEC iQ-R <sup>*2</sup>	MELSEC iQ-L	MELSEC iQ-F <sup>*3</sup>	MELSEC-Q <sup>*4</sup>	MELSEC-L <sup>*4</sup>
UDP port number used in the automatic detection of connected device	Master station: An unused port number is assigned automatically. Slave station: 61451				
Transmission specifications	Data transmission speed	100Mbps			
	Number of cascade connections	100BASE-TX	For the number of the connectable stages when using a switching hub, check with the manufacturer of the switching hub used.		
Network topology	Star topology				
Connection cable	Ethernet cable compliant with the 100BASE-TX standard (☞ Page 19 Ethernet cable)				
Maximum station-to-station distance	100m (ANSI/TIA/EIA-568-B (Category 5e) compliant)				
Overall cable distance	Depends on the system configuration				

\*1 It is the maximum number of connectable modules for a slave station controlled by the master station. It varies depending on the number of stations occupied by a slave station. Ensure that the total number of occupied stations does not exceed the maximum number of connectable modules.

\*2 When using the programmable controller CPU (except for the R00CPU, R01CPU, and R02CPU) with the firmware version "28" or earlier, refer to the following.

☞ Page 10 Performance specifications vary depending on the version of the CPU module

\*3 When using the FX5U CPU module or FX5UC CPU module with the firmware version earlier than "1.110", refer to the following.

☞ Page 10 Performance specifications vary depending on the version of the CPU module

\*4 When using the CPU module with serial number earlier than "19042" (first five digits), refer to the following.

☞ Page 10 Performance specifications vary depending on the version of the CPU module

## Performance specifications vary depending on the version of the CPU module

The following table lists performance specifications vary in the case below.

- MELSEC iQ-R: When the programmable controller CPU (except for the R00CPU, R01CPU, and R02CPU) with the firmware version earlier than "28" is used.
- MELSEC iQ-F: When the FX5U CPU module or FX5UC CPU module with the firmware version earlier than "1.110" is used.
- MELSEC-Q, MELSEC-L: When the CPU module with serial number earlier than "19042" (first five digits) is used

Item		Specifications				
		MELSEC iQ-R	MELSEC iQ-F	MELSEC-Q	MELSEC-L	
Number of connectable modules per network	Slave station	16	6	16	8	
Maximum number of link points per network	RX	1024	384	1024	512	
	RY	1024	384	1024	512	
	RWr	512	192	512	256	
	RWw	512	192	512	256	
Maximum number of link points per station	Master station	RX	1024	384	1024	512
		RY	1024	384	1024	512
		RWr	512	192	512	256
		RWw	512	192	512	256

# 3 FUNCTION LIST

The following table shows whether each function can be used in the master station on CC-Link IE Field Network Basic. For functions when the MELIPC is used as the master station, refer to the following.

 MELIPC MI5000 Series User's Manual (Application)

## Point





Some functions have restrictions on versions of GX Works3/CW Configurator/GX Works2 or the modules and devices of each series that can be used as the master station.

( Page 64 Added and Enhanced Functions)

(1): MELSEC iQ-R, (2): MELSEC iQ-L, (3): MELSEC iQ-F, (4): MELSEC-Q, (5): MELSEC-L

○: Yes, ×: No

## Cyclic transmission

Function	Description	Yes/No			
		(1), (2)	(3)*1	(4)	(5)
Data communication using link devices (RX/Ry/RWr/RWw)	Periodically performs data communication between the master station and slave stations using link devices (RX/Ry/RWr/RWw). (  Page 23 Data flow and link device assignment)	○	○	○	○
Link refresh	Automatically transfers data between devices and link devices of the master station. (  Page 27 Link refresh)	○	○	○	○
Cyclic data integrity assurance	Assures cyclic data integrity in station-based units.	○	○	○	○
Group number setting	Divides slave stations into groups by setting a group number to each slave station and each of groups performs the cyclic transmission. By organizing groups separating slave stations with shorter response processing time from ones with longer response processing time, the differences of the reference response times of each slave station does not badly affect the cyclic transmission. (  Page 31 Group number setting)	○	×	○	×
Input and output status when failure occurs	Clears or holds status of input from a data link faulty station and output status of cyclic data if a stop error occurs in the CPU module (  Page 33 Input and output status when failure occurs)	○	○	○	○
Output status for CPU STOP	Clears or holds cyclic data output when the CPU module is set to STOP state. (  Page 33 Output status for CPU STOP)	○	○	○	○

\*1 For the functions that can be used when the FX5-ENET is used, refer to the following.

 MELSEC iQ-F FX5-ENET User's Manual

## RAS

Function	Description	Yes/No			
		(1), (2)	(3)	(4)	(5)
Slave station disconnection	Disconnects the corresponding slave station if no response is received within the timeout time or number of times for disconnection detection set in the slave station disconnection detection settings. (  Page 41 Link Scan Setting)	○	○	○	○
Automatic return	Automatically returns a disconnected station to the network and restarts the data link when the station returns to normal.	○	○	○	○

## Diagnostics

Function	Description	Yes/No			
		(1), (2)	(3)	(4)	(5)
CC-Link IE Field Network Basic diagnostics	Checks the status of CC-Link IE Field Network Basic. (  Page 46 CC-Link IE Field Network Basic Diagnostics)	○	○	○	○

## Others

Function	Description	Yes/No			
		(1), (2)	(3)	(4)	(5)
Reserved station specification	Reserves a station (a station not actually connected but counted as a connected station) for future use. A reserved station is not detected as a faulty station even though it is not actually connected. (Page 34 Reserved Station Specification)	<input type="radio"/>	<input type="radio"/>	<input type="radio"/>	<input type="radio"/>



# 4 PROCEDURES BEFORE OPERATION

This chapter describes the procedures before operation.

For the procedure when the FX5-ENET is used, refer to the following.

 MELSEC iQ-F FX5-ENET User's Manual

## 1. Configuring a network system

Configure a network system. ( Page 15 SYSTEM CONFIGURATION,  Page 14 Wiring precautions)

## 2. Setting parameters of the master station

- IP address setting (such as IP address, subnet mask)
- CC-Link IEF Basic setting ( Page 35 Settings for MELSEC iQ-R/MELSEC iQ-L/MELSEC iQ-F,  Page 43 Settings for MELSEC-Q/MELSEC-L)

### Point

Actually connected devices can be detected by the automatic detection of connected device and reflected in the network configuration setting. ( Page 38 Automatic detection of connected device)

In the network configuration setting, communication settings, such as IP addresses and subnet masks, and writing/reading parameters that are inherent in the slave stations can also be performed to the slave stations. (Some slave stations do not support these features.)

## 3. Configure the necessary settings of the slave station such as the IP address and subnet mask. ( Manual for the slave station used)

## 4. Write parameters to the CPU module and the MELIPC on the master station. ( Operating manual for the tool used)

## 5. Start up the slave stations.

## 6. Cyclic transmission starts if the CPU module and the MELIPC on the master station are powered off and on or reset.

## 7. Diagnosing a network

Check the status of a network by executing the CC-Link IE Field Network Basic diagnostics. ( Page 46 CC-Link IE Field Network Basic Diagnostics)

## 8. Programming

Create a program. For details, refer to the following.

 Page 20 PROGRAMMING

## Wiring precautions

- Place the Ethernet cables in a duct or clamp them. If not, dangling cable may swing or inadvertently be pulled, resulting in damage to the module or cables or malfunction due to poor contact.
- Do not touch the core of the cable-side or module-side connector, and protect it from dirt or dust. If oil from your hand, dirt or dust is attached to the core, it can increase transmission loss, arising a problem in data link.
- Check that the Ethernet cable is not disconnected or not shorted and there is no problem with the connector connection.
- Do not use Ethernet cables with broken latches. Doing so may cause the cable to unplug or malfunction.
- Hold the connector part when connecting and disconnecting the Ethernet cable. Pulling the cable connected to the module may result in malfunction or damage to the module or cable.
- For connectors without Ethernet cable, attached connector cover should be placed to prevent foreign matter such as dirt or dust.
- The maximum segment length of the Ethernet cable is 100m. However, the length may be shorter depending on the operating environment of the cable. For details, contact the manufacturer of the cable used.
- The bending radius of the Ethernet cable is limited. For details, check the specifications of the Ethernet cable to be used.
- For a cascade connection, recommended number of levels is up to three. If connected four levels or more, a packet loss caused by switching hubs is more likely to occur.



# 5 SYSTEM CONFIGURATION

This chapter describes the system configuration of CC-Link IE Field Network Basic.

## 5.1 CC-Link IE Field Network Basic System Configuration

Configure a network system using modules and partner products supporting CC-Link IE Field Network Basic.

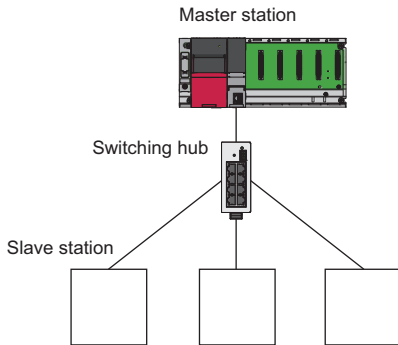

For the system configuration of CC-Link IE Field Network Basic with the MELIPC, refer to the following.

 MELIPC MI5000 Series User's Manual (Startup)

### Network topology

Use a standard Ethernet cable and switching hub and connect slave stations in star topology.

# Access range

The access range of CC-Link IE Field Network Basic is within the same network address of Ethernet. The device connected beyond a router is not accessible.

**Ex.**

When the subnet mask is 255.255.255.0 and the network address is 192.168.3.□

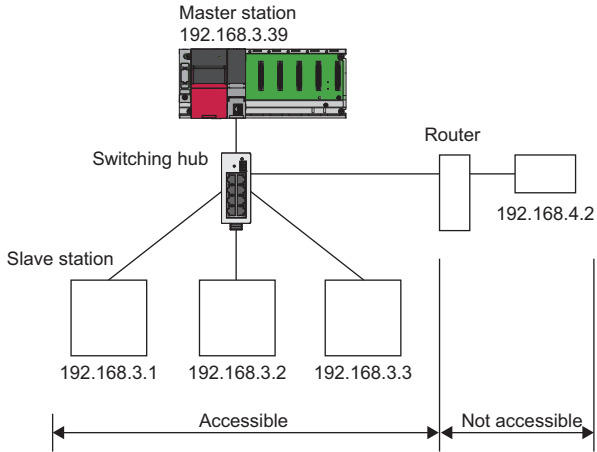

**Point**

Use the same subnet mask value and do not assign the same IP address for each slave station.

## Number of link points

The number of link points per slave station is 64 points for RX/RX and 32 points for RWr/RWw. (☞ Page 8 Performance Specifications)

However, by changing the number of occupied stations, RX/RX can be set to a maximum of 256 points in increments of 64 points and RWr/RWw can be set to a maximum of 128 points in increments of 32 points. For details on the number of occupied stations (whether or not the number can be changed), refer to the manual for the slave station used.

If the number of link points for the slave station is changed, the assignment range and station number are changed.

**Ex.**

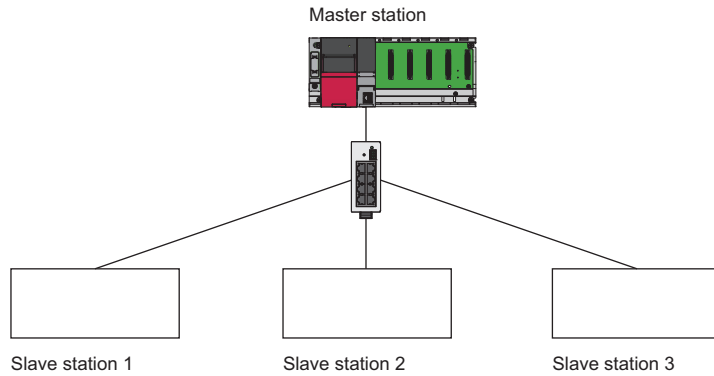

- Slave station 1: 1 station occupied
- Slave station 2: 2 stations occupied
- Slave station 3: 4 stations occupied

The following table lists the number of link points.

Slave station	Number of occupied stations	RX/RX			RWr/RWw		
		Number of points	Start	End	Number of points	Start	End
1	1	64	0	3F	32	0	1F
2	2 stations occupied	128	40	BF	64	20	5F
3	4 stations occupied	256	C0	1BF	128	60	DF



Setting the number of link points for a slave station to 2 stations occupied means that two slave stations are connected. Thus, if the number of link points is increased, the number of connectable slave stations per network is decreased.

## 5.2 Product List

This section describes the products which configure a CC-Link IE Field Network Basic system.

### Modules and devices can be used as the master station

The following tables list the modules and devices that can be used as the master station of CC-Link IE Field Network Basic. To check the firmware version of them, refer to the following.

☞ Page 64 Added and Enhanced Functions

#### MELSEC iQ-R

Product name	Model name
Programmable controller CPU	R00CPU, R01CPU, R02CPU, R04CPU, R04ENCPU, R08CPU, R08ENCPU, R16CPU, R16ENCPU, R32CPU, R32ENCPU, R120CPU, R120ENCPU
C Controller module	R12CCPU-V

#### MELSEC iQ-L

Product name	Model name
CPU module	L04HCPU, L08HCPU, L16HCPU

#### MELSEC iQ-F

Product name	Model name
FX5UJ CPU module	FX5UJ-24MR/ES, FX5UJ-24MT/ES, FX5UJ-24MT/ESS, FX5UJ-40MR/ES, FX5UJ-40MT/ES, FX5UJ-40MT/ESS, FX5UJ-60MR/ES, FX5UJ-60MT/ES, FX5UJ-60MT/ESS
FX5U CPU module	FX5U-32MR/ES, FX5U-32MT/ES, FX5U-32MT/ESS, FX5U-64MR/ES, FX5U-64MT/ES, FX5U-64MT/ESS, FX5U-80MR/ES, FX5U-80MT/ES, FX5U-80MT/ESS, FX5U-32MR/DS, FX5U-32MT/DS, FX5U-32MT/DSS, FX5U-64MR/DS, FX5U-64MT/DS, FX5U-64MT/DSS, FX5U-80MR/DS, FX5U-80MT/DS, FX5U-80MT/DSS
FX5UC CPU module	FX5UC-32MT/D, FX5UC-32MT/DSS, FX5UC-64MT/D, FX5UC-64MT/DSS, FX5UC-96MT/D, FX5UC-96MT/DSS, FX5UC-32MT/DS-TS, FX5UC-32MT/DSS-TS, FX5UC-32MR/DS-TS
FX5 intelligent function module	FX5-ENET

#### MELSEC-Q

Product name	Model name
High-speed Universal model QCPU	Q03UDVCP, Q04UDVCP, Q06UDVCP, Q13UDVCP, Q26UDVCP

#### MELSEC-L

Product name	Model name
Built-in Ethernet port LCP	L02CPU, L02CPU-P, L06CPU, L06CPU-P, L26CPU, L26CPU-P, L26CPU-BT, L26CPU-PBT

#### MELIPC

Product name	Model name
MELIPC MI5000 series	MI5122-VW

## Modules and devices can be used as a slave station

For modules and devices which can be used as a slave station of CC-Link IE Field Network Basic, refer to the manual for each module and device.

### Point

The modules and devices that can be used as the master station cannot be used as a slave station. (Page 18 Modules and devices can be used as the master station)

## Wiring products

This section describes the wiring products used in CC-Link IE Field Network Basic.

### Ethernet cable

Use an Ethernet cable which conforms to the following standards.

Ethernet cable	Connector	Standard
Category 5 or higher, (STP) straight cable	RJ45 connector	• IEEE802.3 (100BASE-TX) • ANSI/TIA/EIA-568-B (Category 5)
Category 5 or 5e, (STP) crossover cable		

### Hub

Use hubs which satisfy all the following conditions. If hubs not satisfying the conditions are used, operation is not guaranteed.

- IEEE802.3 (100BASE-TX) compliant
- The auto MDI/MDI-X function equipped
- The auto-negotiation function equipped
- Switching hub (layer 2 switch)<sup>\*1</sup>

\*1 A repeater hub cannot be used.

For switching hubs that can be used for CC-Link IE Field Network Basic, refer to the following.

📖 Applicable products (switching hubs) for CC-Link IE Field Network Basic module (FA-A-0234)

# 6 PROGRAMMING

This chapter describes the programming of CC-Link IE Field Network Basic.

When the C Controller module is used, refer to the following.

 MELSEC iQ-R C Controller Module User's Manual (Application)

When the FX5-ENET is used, refer to the following.

 MELSEC iQ-F FX5-ENET User's Manual

When the MELIPC is used, refer to the following.

 MELIPC MI5000 Series User's Manual (Application)

## 6.1 Interlock Programs of Cyclic Transmission

When creating a cyclic transmission program, configure an interlock such that the processing is performed when normal cyclic transmission between the master station and slave stations is performed.

### Point

For details on special relay areas (SM) and special register areas (SD), refer to the following.

 Page 58 List of SM/SD/Buffer Memory Areas for CC-Link IE Field Network Basic

### Program using labels

A program using labels is provided below.

#### Labels used in the program

##### ■Module label

The following module labels are used.

Module label			Description	Device
MELSEC iQ-R	MELSEC iQ-L	MELSEC iQ-F		
RCPU.stSM.bSts_CyclicTransmission	LHCPU.stSM.bSts_CyclicTransmission	FX5CPU.stSM.bSts_CyclicTransmission	Cyclic transmission status	SM1536
RCPU.stSD.bnSts_CyclicTransmission_Station[1]	LHCPU.stSD.bnSts_CyclicTransmission_Station[1]	FX5CPU.stSD.bnSts_CyclicTransmission_Station[1]	Cyclic transmission status of each station (station No.1)	SD1536.0
RCPU.stSD.bnSts_CyclicTransmission_Station[2]	LHCPU.stSD.bnSts_CyclicTransmission_Station[2]	FX5CPU.stSD.bnSts_CyclicTransmission_Station[2]	Cyclic transmission status of each station (station No.2)	SD1536.1

##### ■Labels to be defined

Define global labels as follows.

	Label Name	Data Type	Class	Assign (Device/Label)
1	bStartDirection_1	Bit	VAR_GLOBAL	M200
2	bStartDirection_2	Bit	VAR_GLOBAL	M201

## Program example

The following is a program example of MELSEC iQ-R series.

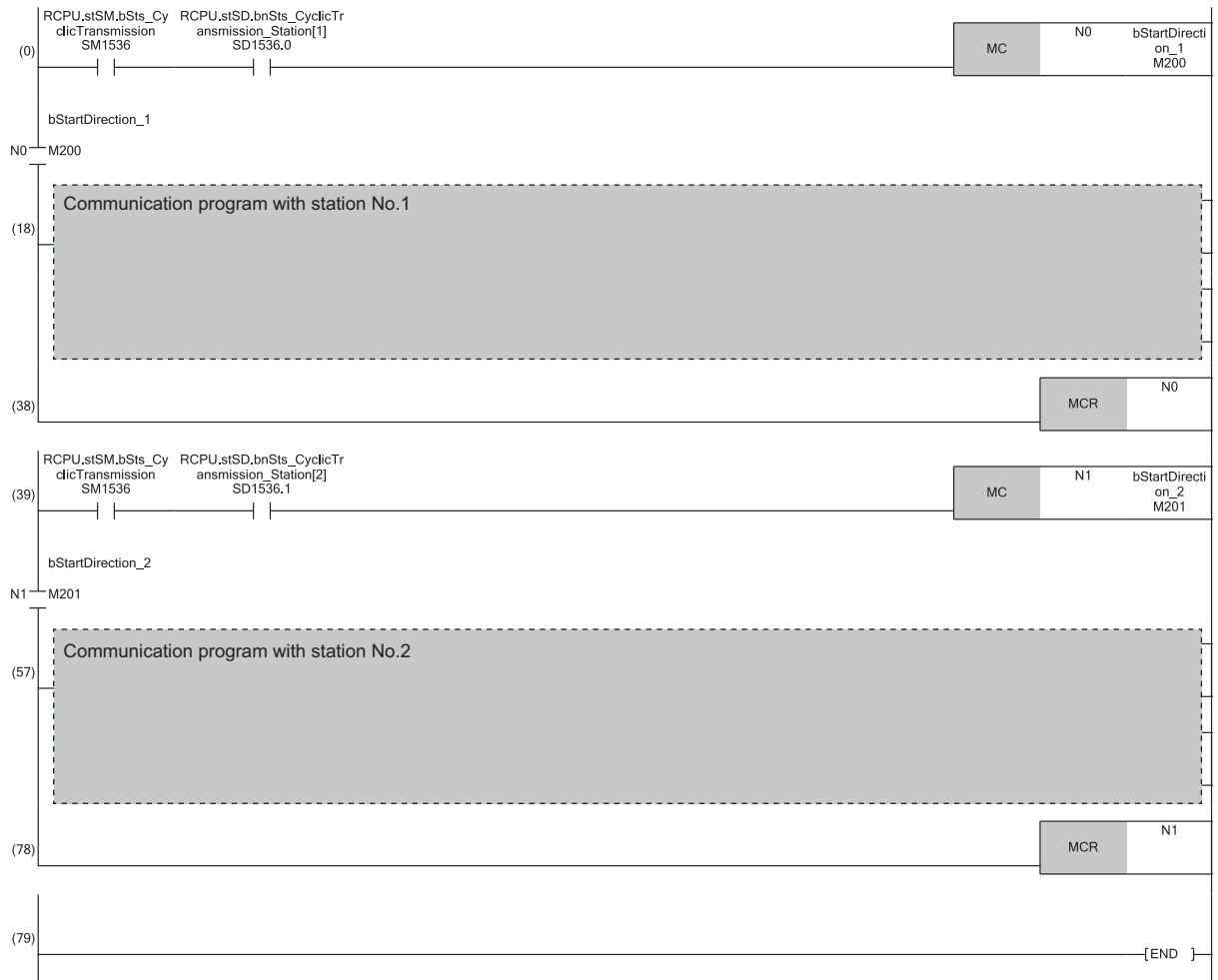

# Program using devices

A program using devices is provided below.

## Devices used in the program

The following devices are used.

Device		Description
MELSEC iQ-R, MELSEC iQ-L, MELSEC iQ-F	MELSEC-Q, MELSEC-L	
SM1536	SM1700	Cyclic transmission status
SD1536.0	SD1700.0	Cyclic transmission status of each station (station No.1)
SD1536.1	SD1700.1	Cyclic transmission status of each station (station No.2)

## Program example

The following is a program example of MELSEC-Q series.

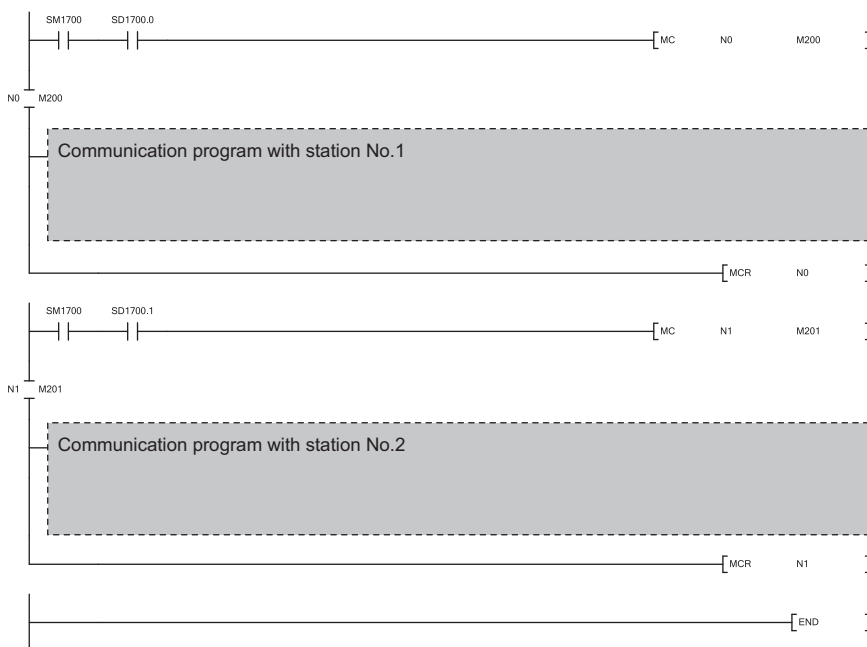



# 7 FUNCTIONS

This chapter describes the functions of CC-Link IE Field Network Basic.

When the C Controller module is used, refer to the following.

📖 MELSEC iQ-R C Controller Module User's Manual (Application)

When the MELIPC is used, refer to the following.

📖 MELIPC MI5000 Series User's Manual (Application)

## 7.1 Cyclic Transmission

This function periodically performs data communication between the master station and slave stations using link devices.

### Data flow and link device assignment

The following figure shows the data flow of communications using link devices between the master station and slave stations.

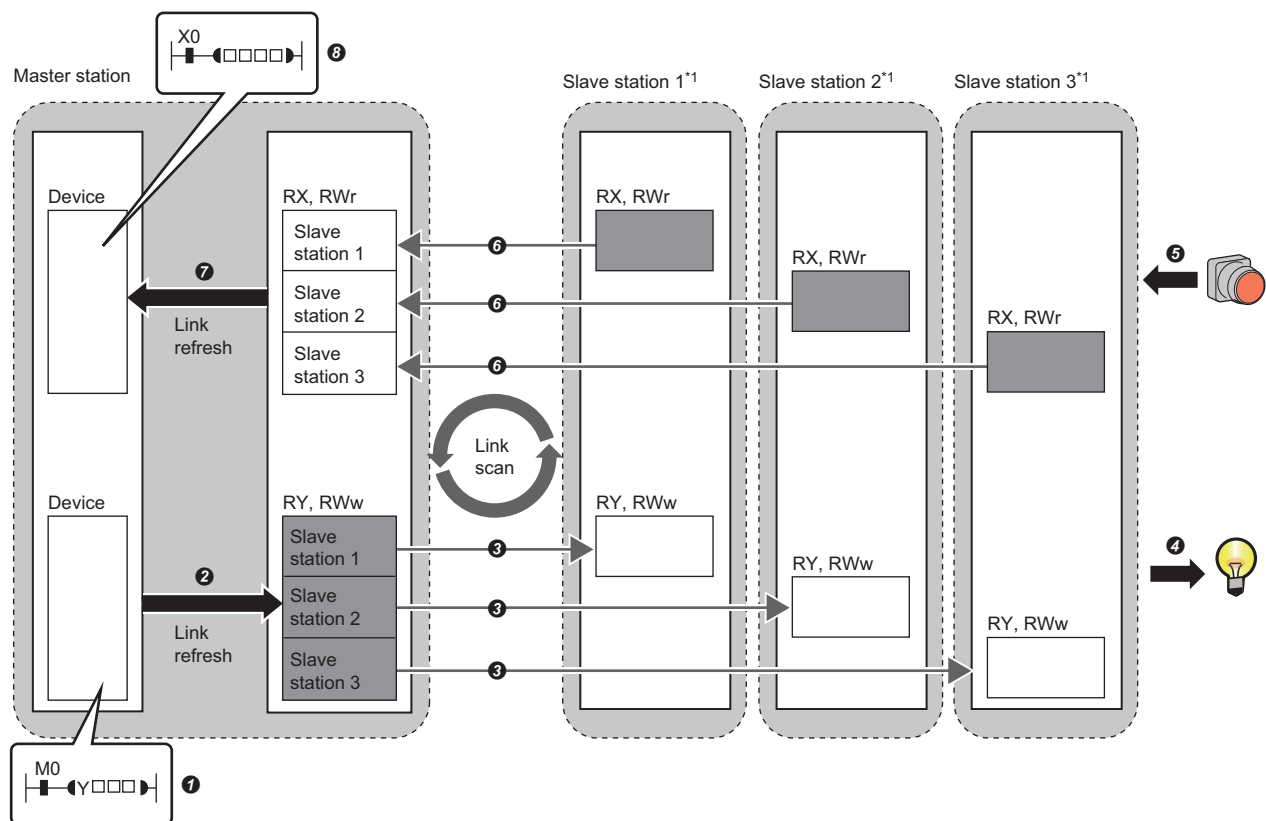

■ : Area where data is sent to other stations

\*1 The slave station order is the same as the order set in the network configuration setting. (📖 Page 37 Network Configuration Settings)

#### • Output from the master station

- ① The devices of the master station turn on.
- ② The status of the devices of the master station is stored in the link devices (RY, RWw) of the master station by link refresh.
- ③ The status of link devices (RY, RWw) of the master station is stored in the link devices (RY, RWw) of each slave station by link scan.
- ④ The status of the link devices (RY, RWw) of the slave station is output to external devices.

#### • Input from the slave station

- ⑤ The status of external devices is stored in the link devices (RX, RWr) of each slave station.
- ⑥ The status of the link devices (RX, RWr) of each slave station is stored in the link devices (RX, RWr) of the master station by link scan.
- ⑦ The status of the link devices (RX, RWr) of the master station is stored in the devices of the master station by link refresh.
- ⑧ The devices of the master station turn on.

## Setting method

Assignments of link devices are configured in "Network Configuration Settings". (☞ Page 37 Network Configuration Settings)

Assignments for link refresh are configured in "Refresh Settings". (☞ Page 42 Refresh Settings, ☞ Page 43 CC-Link IEF Basic settings)

### Point

Groups of slave stations (16 stations maximum) individually perform the cyclic transmission. (☞ Page 31 Group number setting)

For assignments of link devices and ones for link refresh, however, there is no to consider the groups.

## Data flow of cyclic transmission

The following describes the data flow of cyclic transmission.

### Basic operation

The master station sends a request to all slave stations (including Ethernet devices within the same network address).

After receiving responses from all slave stations set with parameters, the master station starts sending another request. The link scan refers to the operation from sending a request to sending another request and the link scan time refers to the time required for a link scan. (☞ Page 29 Operation of the link scan)

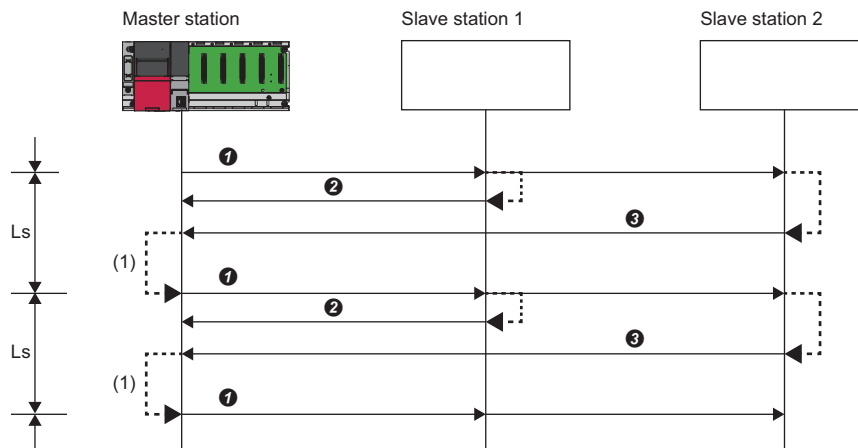

Ls: Link scan

❶ The master station sends a request to slave station 1 and slave station 2.

❷ Slave station 1 sends a response to the master station.

❸ Slave station 2 sends a response to the master station.

(1) Once the master station has received responses from slave station 1 and slave station 2, the master station starts sending another request.

### Point

- When the master station sends a request (starts cyclic transmission) to all slave stations, 'Cyclic transmission status' (SM1536) turns on, and when the master station receives responses from each slave station, a bit, that is corresponding to the station number of the slave stations which have sent a response, of 'Cyclic transmission status of each station' (SD1536 to SD1539) turns on.
- When the master station starts cyclic transmission, if no response has been received from a slave station, the applicable slave station is not detected as a faulty station. (The 'Data link status' (SM1540) does not turn on.) In addition, the transmission status of CC-Link IE Field Network Basic diagnostics becomes "Unfixed".
- When slave stations are divided into groups, each of the groups performs the cyclic transmission. For the data flow of group number setting, refer to the following.

☞ Page 32 Data flow of cyclic transmission

## ■No response received from a slave station

If the master station is unable to receive a response from a slave station due to the power-off or cable disconnection of the slave station, the master station waits for a response from the slave station within the timeout time set in the link scan settings. If no response is received within the specified number of times for disconnection detection, the master station disconnects the slave station.

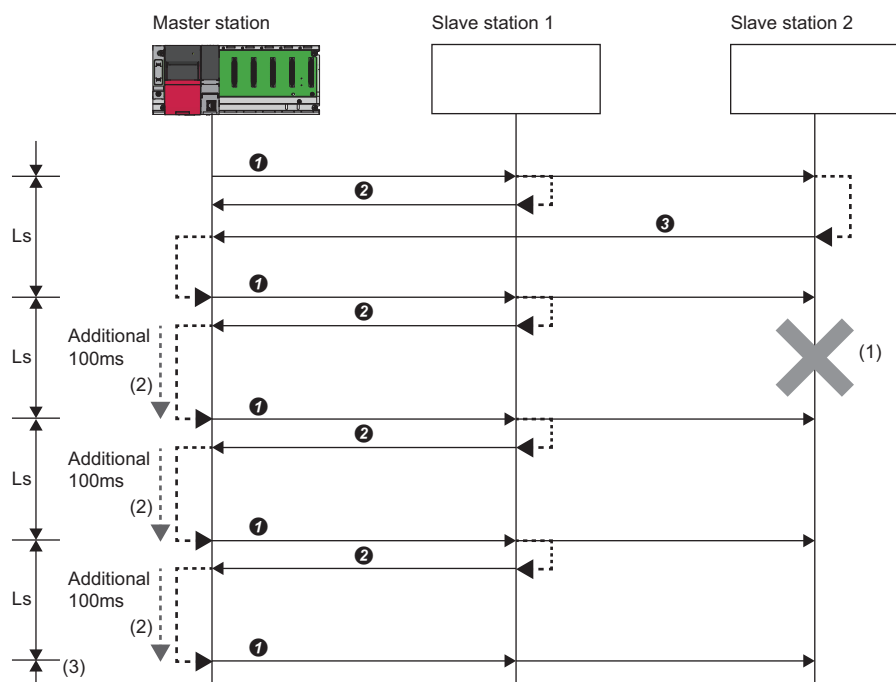

(Slave station disconnection detection setting: Timeout time = 100ms, number of times = 3 times)

Ls: Link scan

① The master station sends a request to slave station 1 and slave station 2.

② Slave station 1 sends a response to the master station.

③ Slave station 2 sends a response to the master station.

(1) Slave station 2 cannot respond to the master station due to an error such as power-off or cable disconnection of the slave station.

(2) The master station waits for the response from slave station 2 until the timeout time runs out and then send a request to slave station 1 and slave station 2 because the master station cannot receive a response from slave station 2. Note that the link scan time is extended by the timeout time.

(3) The master station disconnect slave station 2 because the master station cannot receive a response from slave station 2 by the specified number of times (three times) for the disconnection detection.

The following table lists the special relay and special register operations when a slave station which did not send a response is disconnected.

Special relay/special register	Operation
'Cyclic transmission status' (SM1536)	Remains turned on.
'Cyclic transmission status of each station' (SD1536 to SD1539)	The bit corresponding to the station number of the disconnected slave station is turned off.
'Data link status' (SM1540)	Turns off and on.
'Data link status of each station' (SD1540 to SD1543)	The bit corresponding to the station number of the disconnected slave station is turned on (indicating that the slave station is a faulty station).

### Point

- If a timeout due to a failure of a slave device occurs, a timeout time will be equivalent to a link scan time. To lessen the impact on communications with normal slave stations by transmission delay, adjust the timeout time. (☞ Page 41 Link Scan Setting) For example, check the current link scan time (when all slave stations normally operate) using the CC-Link IE Field Network Basic diagnostics, and then specify a value, which is about five times as long as the link scan time, for timeout time. (When the current link scan time is 10ms, specify 50ms for the timeout time.)
- The delay in the link scan time caused by a timeout can be checked in 'Accumulated number of timeouts' (UnG1063). (☞ Page 52 Acquiring diagnostic information of slave stations)

## ■An abnormal response received from a slave station

The master station immediately disconnects the slave station regardless of the timeout time and the number of times for disconnection detection set in the link scan settings.

The following table lists the special relay and special register operations when a slave station is disconnected.

Special relay/special register	Operation
'Cyclic transmission status' (SM1536)	Remains turned on.
'Cyclic transmission status of each station' (SD1536 to SD1539)	The bit corresponding to the station number of the disconnected slave station is turned off.
'Data link status' (SM1540)	Turns off and on.
'Data link status of each station' (SD1540 to SD1543)	The bit corresponding to the station number of the disconnected slave station is turned on (indicating that the slave station is a faulty station).

### Point

Some slave stations are equipped with a function that makes them disconnected without being a faulty station<sup>\*1</sup>. For details, refer to the manuals of the slave station used.

<sup>\*1</sup> Since the slave station does not become a faulty station, 'Data link status' (SM1540) and 'Data link status of each station' (SD1540 to SD1543) do not change.

# Link refresh

This function automatically transfers data between devices and link devices of the master station. Link refresh is performed in END processing.\* 1

\*1 It is also performed at the arbitrary timing of the COM instruction (Selecting refresh to be performed). (MELSEC iQ-F does not support the COM instruction.)

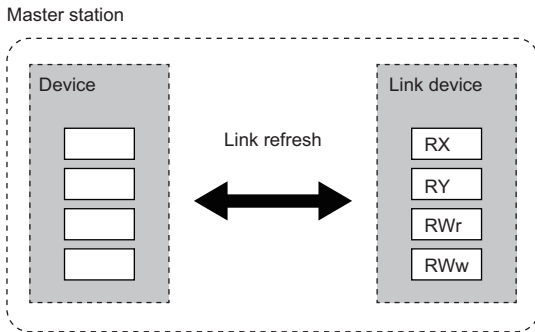

## Concept of the link refresh range (number of points)

A batch refresh is performed for all the stations set in the parameter starting from the head of the link device.

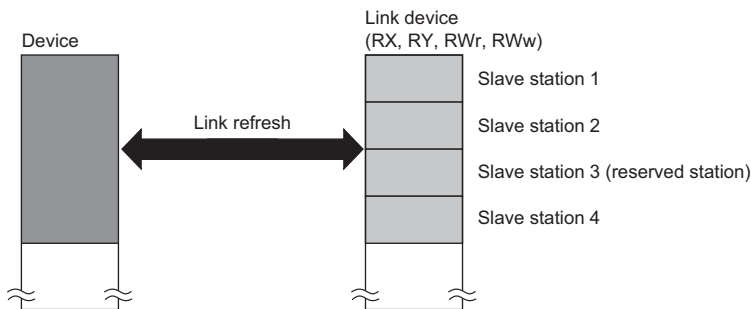

**Point**

A reserved station is also included in the refresh range.

## Setting method

Link refresh is assigned in "Refresh Settings" under "CC-Link IEF Basic Setting". (☞ Page 42 Refresh Settings, ☞ Page 43 CC-Link IEF Basic settings)

## Precautions

### ■ Latched devices of the CPU module

If data in latched devices of the CPU module is cleared to zero in a program when the CPU module is powered off and on or reset, the data may be output without being cleared to zero, depending on the timing of link scan and link refresh. Take the following actions so as not to output the data in the latched devices of the CPU module.

CPU module device	How to disable the device data
File register (R, ZR)*1	Use the device initial value to clear the device to zero.
Latch relay (L)	Delete from the refresh settings
Devices within the latch range, extended data register (D)*2 and extended link register (W)*2	Delete all the latch range settings.

\*1 In the FX5U CPU modules and FX5UC CPU modules, the file register (R) is latched when it is specified to be included in the latch range.

\*2 The devices are available for MELSEC-Q and MELSEC-L. (☞ User's Manual (Function Explanation, Program Fundamentals) for the CPU module used)

## ■Boundary between extended data register (D) and extended link register (W)

Do not set the refresh range beyond the boundary between the user device and extended data register (D)<sup>\*1</sup> or extended link register (W)<sup>\*1</sup>.

\*1 The devices are available for MELSEC-Q and MELSEC-L. (📖 User's Manual (Function Explanation, Program Fundamentals) for the CPU module used)

# Operation of the link scan

This section describes the operation of the link scan.

## MELSEC iQ-R, MELSEC iQ-L, MELSEC-Q, MELSEC-L

After sending the requests to all of slave stations and subsequently receiving responses from all the slave stations, the master station starts the next link scan. Link refresh is performed in END processing after receiving responses from all the slave stations.

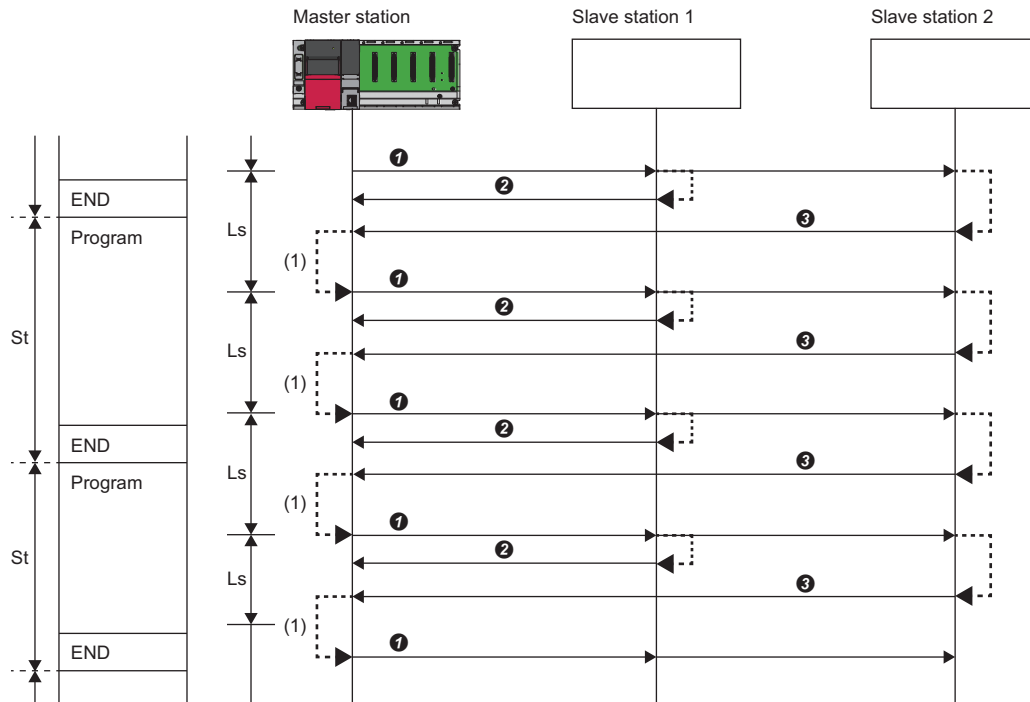

St: Scan time (sequence scan)

Ls: Link scan

END: END processing

① The master station sends a request to slave station 1 and slave station 2.

② Slave station 1 sends a response to the master station.

③ Slave station 2 sends a response to the master station.

(1) Once the master station has received responses from slave station 1 and slave station 2, the master station starts the next link scan.

### Point

- The link scan operates separately from the operation of programs.
- If the scan time is smaller than link scan time, link refresh is not performed until the master station receives responses from all slave stations.
- The link scan time may increase five times longer than the normal time depending on the processing load or communication load of the master station. Set an appropriate time for the timeout time. (☞ Page 24 Data flow of cyclic transmission, ☞ Page 41 Link Scan Setting)

## MELSEC iQ-F

After sending requests to all slave stations, the master station receives responses from slave stations in END processing. After receiving responses from all the slave stations, the master station performs link refresh and starts the next link scan.

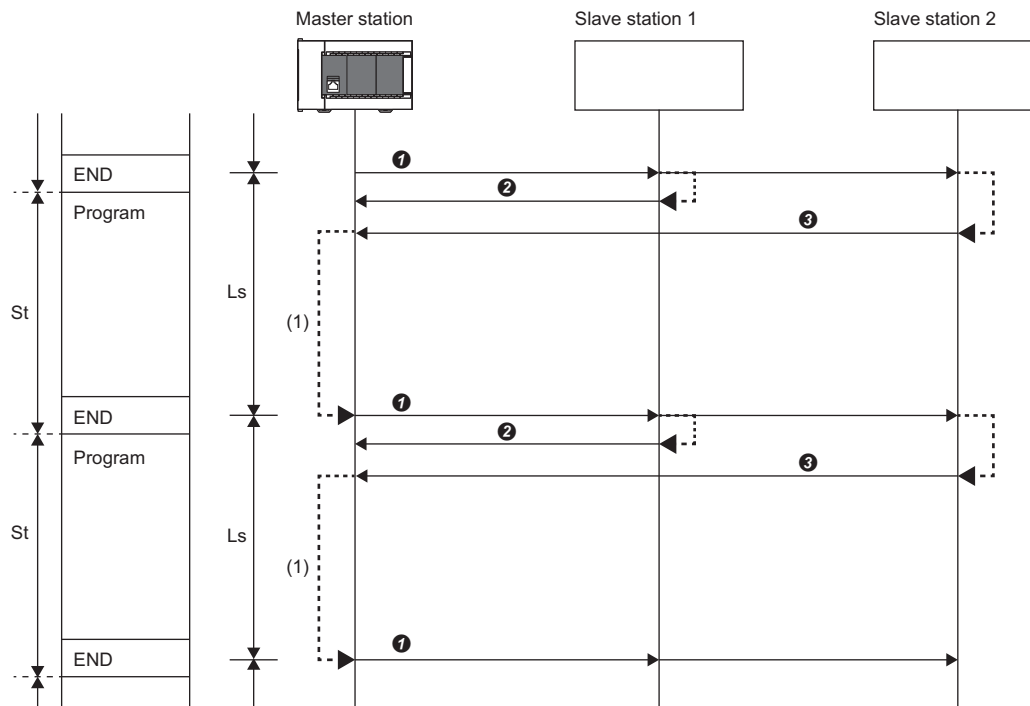

St: Scan time (sequence scan)

Ls: Link scan

END: END processing



① The master station sends a request to slave station 1 and slave station 2.

② Slave station 1 sends a response to the master station.

③ Slave station 2 sends a response to the master station.

(1) Although the master station received responses from slave station 1 and slave station 2, the master station does not start the next link scan until link refresh is performed in END processing.

### Point

- If the scan time is smaller than link scan time, link refresh is not performed until the master station receives responses from all slave stations.
- The link scan time may increase five times longer than the normal time depending on the processing load or communication load of the master station. Set an appropriate time for the timeout time. (  Page 24 Data flow of cyclic transmission,  Page 41 Link Scan Setting)



## Group number setting

This function divides slave stations into groups by setting a group number to each slave station and each of groups performs the cyclic transmission.

By organizing groups separating slave stations with shorter response processing time from ones with longer response processing time, the differences of the reference response times of each slave station does not badly affect the cyclic transmission.

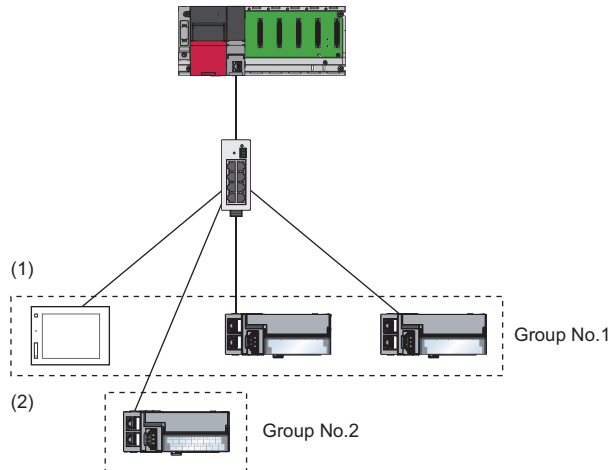

- (1)The total number of occupied stations for one group is 16 maximum.  
(2)Up to four groups can be organized.

### Restriction

Before using the group number setting, check the versions of the CPU module and the engineering tool. ( Page 64 Added and Enhanced Functions)

Note, however, there is no restriction for the R00CPU, R01CPU, and R02CPU.

## How to organize groups

Organize groups considering the following.

### ■Dividing slave stations into groups

- Organizing two or more groups can configure a network with slave stations that occupy 17 or more stations in total.
- By dividing slave stations into groups with similar reference response time, the gap of the response time of each slave station does not badly affect the cyclic transmission. For details on the reference response time, refer to manuals for slave stations used. Link scan times vary from group to group. The link scan time of each group is affected by a slave station that has the longest reference response time in a group. ( Page 32 Data flow of cyclic transmission)

### ■Merging slave stations into one group

- To perform cooperating operation between slave stations, merge them into the same group.
- When the line load is large, merging slave stations into the fewest number of groups as possible according to the number of slave stations connected to the master station is recommended. For example, merge slave stations into one group if the slave stations are 16 or less. When two or more groups are organized, the master station sends requests to each of them. Since the packets of the cyclic transmissions performed for each group flow on the line, the more groups are organized, the larger the line load becomes.

## Data flow of cyclic transmission

The following describes the data flow of cyclic transmission of when the group number setting is used.

### Basic operation

The master station sends requests, that vary from a group to group, to all slave stations. Although slave stations receive multiple request messages from the master station, each slave station handles a request message for a group where each slave stations belong to.

After receiving responses from all the slave stations in a group, the master station starts sending another request to the group. For this reason, link scan times vary from group to group.

Since the link scan setting can be configured for each group, the setting can be according to response processing times of each group. (☞ Page 41 Link Scan Setting)

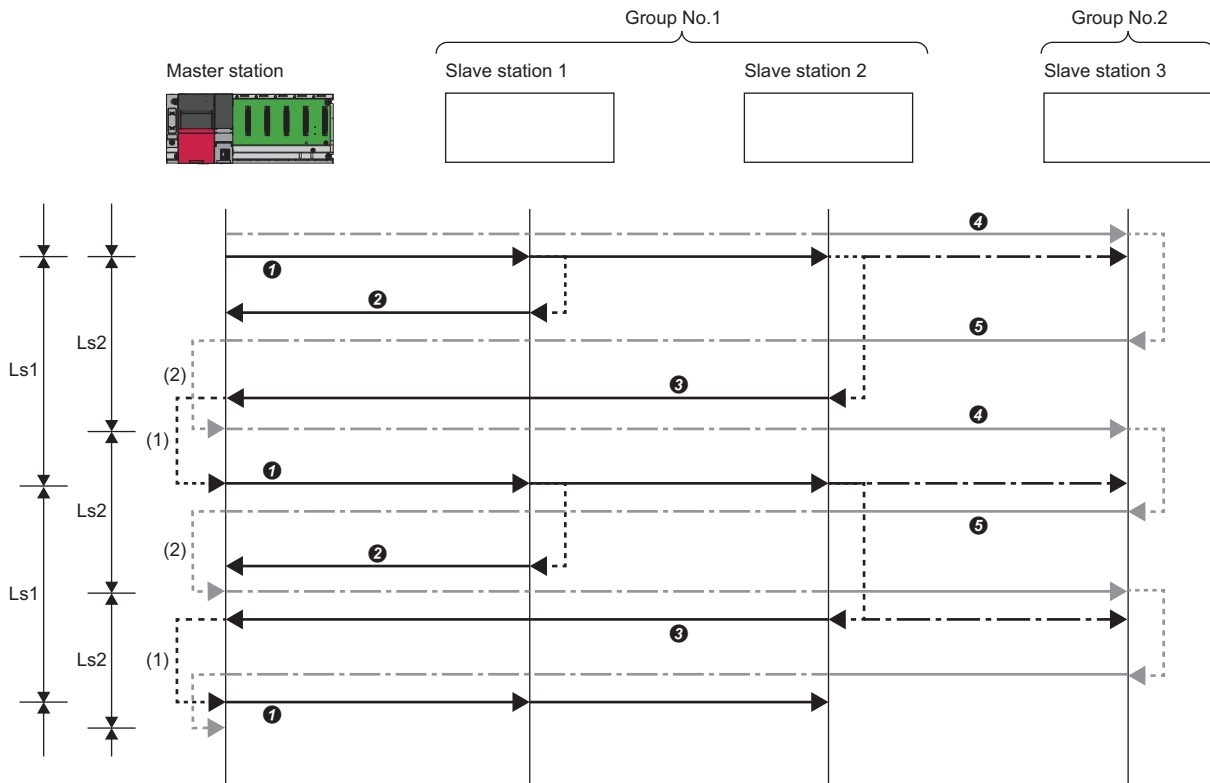

Ls1: Link scan of group 1

Ls2: Link scan of group 2

① The master station sends requests to slave station 1 and slave station 2 that belong to group 1.

② Slave station 1 sends a response to the master station.

③ Slave station 2 sends a response to the master station.

④ The master station sends requests to slave station 3 that belongs to group 2.

⑤ Slave station 3 sends a response to the master station.

(1) Once the master station has received responses from slave station 1 and slave station 2, the master station starts sending another request.

(2) Once the master station has received a response from slave station 3, the master station starts sending another request.

### Setting method

The group number setting is configured in "Network Configuration Settings". (☞ Page 37 Network Configuration Settings)

# Input and output status when failure occurs

This section describes the status of input from a data link faulty station and output status of cyclic data if a stop error occurs in the CPU module.

Status	Operation
Input status from data link faulty station	RX is cleared. Regarding RWr, the data before an error occurs is held.
Cyclic data output when a stop error occurs in the CPU module	<ul style="list-style-type: none"> <li>MELSEC iQ-R, MELSEC iQ-L, MELSEC-Q, MELSEC-L: Data is held.</li> <li>MELSEC iQ-F: Data is cleared.</li> </ul>

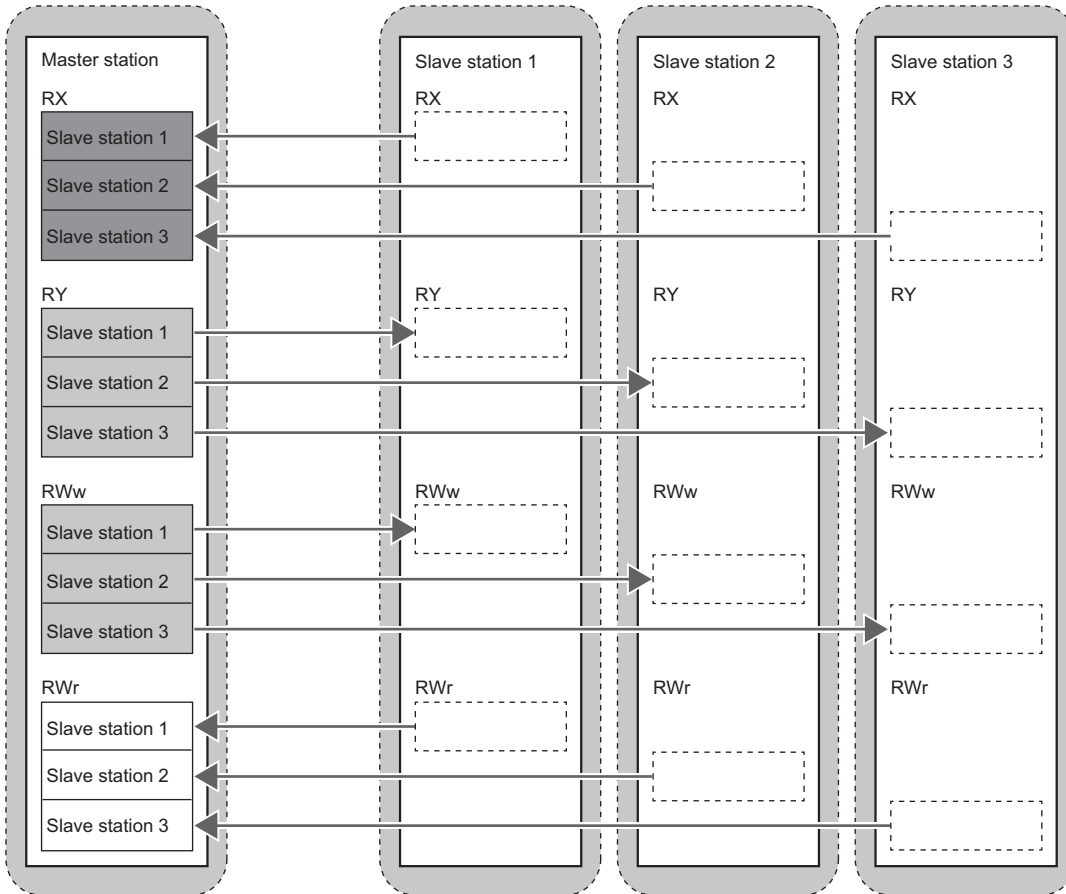

- : Area where the input from a faulty station is cleared
- : Area where the operation (clear/hold) differs depending on the CPU module
- : Area where data is held
- : Area where the operation depends on the settings on the slave station side

## Output status for CPU STOP

The following are cyclic data outputs when the CPU module is in the STOP state.

- MELSEC iQ-R, MELSEC iQ-L, MELSEC-Q, MELSEC-L: Data is held. However, when the device set to perform link refresh is Y device, the data is cleared.
- MELSEC iQ-F: Data is cleared.

## 7.2 Reserved Station Specification

This function reserves a station (a station not actually connected but counted as a connected station) for future use. A reserved station is not detected as a faulty station even though it is not actually connected.

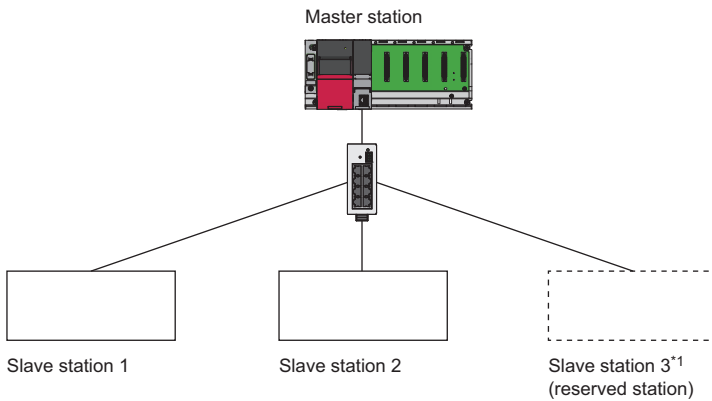

\*1 The station is not actually connected.

### Point

A reserved station is also included in the refresh range.

### Setting method

Specify a slave station as a reserved station in the network configuration settings. (➡ Page 37 Network Configuration Settings)

### Point

Items such as the number of occupied stations and IP address can be set for a reserved station.

# 8 PARAMETER SETTINGS

This chapter describes the parameter settings for the master station.

## 8.1 Settings for MELSEC iQ-R/MELSEC iQ-L/MELSEC iQ-F

Use GX Works3 for master station settings.

When the C Controller module is used, refer to the following.

 MELSEC iQ-R C Controller Module User's Manual (Application)

When the FX5-ENET is used, refer to the following.

 MELSEC iQ-F FX5-ENET User's Manual

### CC-Link IEF Basic settings

#### IP address settings

The IP address settings for the master station must be configured before configuring the CC-Link IEF Basic settings.

- MELSEC iQ-R, MELSEC iQ-L

 [Navigation window] ⇒ [Parameter] ⇒ [CPU module model name] ⇒ [Module Parameter] ⇒ [Basic Settings] ⇒ [Own Node Settings]

- MELSEC iQ-F

 [Navigation window] ⇒ [Parameter] ⇒ [CPU module model name] ⇒ [Module Parameter] ⇒ [Ethernet Port] ⇒ [Basic Settings] ⇒ [Own Node Settings]

#### Window

Item	Setting
Own Node Settings	
Parameter Setting Method	Parameter Editor
IP Address	
IP Address	. . .
Subnet Mask	. . .
Default Gateway	. . .

#### Displayed items

Item	Setting range
IP Address	0.0.0.1 to 223.255.255.254
Subnet Mask	0.0.0.1 to 255.255.255.255 When there is no value to set, any one of the following recommended values. <ul style="list-style-type: none"> <li>• 255.0.0.0 (For the IP address whose first octet is 127 or less)</li> <li>• 255.255.0.0 (For the IP address whose first octet is between or equal to 128 and 191)</li> <li>• 255.255.255.0 (For the IP address whose first octet is 192 or greater)</li> </ul>
Default Gateway	0.0.0.1 to 223.255.255.254 When there is no value to set, use an IP address that is not used for the network.

**Ex.**

Item	Setting
Own Node Settings	
Parameter Setting Method	Parameter Editor
IP Address	
IP Address	192 . 168 . 3 . 39
Subnet Mask	255 . 255 . 255 . 0
Default Gateway	192 . 168 . 3 . 254

## CC-Link IEF Basic settings

This section describes how to configure the basic settings such as whether to use CC-Link IE Field Network Basic.

- MELSEC iQ-R, MELSEC iQ-L

 [Navigation window] ⇒ [Parameter] ⇒ [CPU module model name] ⇒ [Module Parameter] ⇒ [Basic Settings]



- MELSEC iQ-F

 [Navigation window] ⇒ [Parameter] ⇒ [CPU module model name] ⇒ [Module Parameter] ⇒ [Ethernet Port] ⇒ [Basic Settings]

### Window

Item	Setting
▣ CC-Link IEF Basic Setting	
└ To Use or Not to Use CC-Link IEF Basic Setting	Disable
└ Network Configuration Settings	<Detailed Setting>
└ Refresh Settings	<Detailed Setting>

### Displayed items

Item	Description	Setting range	Default
To Use or Not to Use CC-Link IEF Basic Setting	Set whether to use CC-Link IE Field Network Basic.	<ul style="list-style-type: none"> <li>• Enable</li> <li>• Disable</li> </ul>	Disable
Network Configuration Settings	Set the information of the slave station to the master station. Moreover, configure link scan settings (timeout time and number of retries for slave station disconnection detection). (  Page 37 Network Configuration Settings)	—	—
Refresh Settings	Configure the settings to automatically link refresh RX/Ry/RWr/RWw data to the devices. (  Page 42 Refresh Settings)	—	—

# Network Configuration Settings

Set the network configuration.

## Window

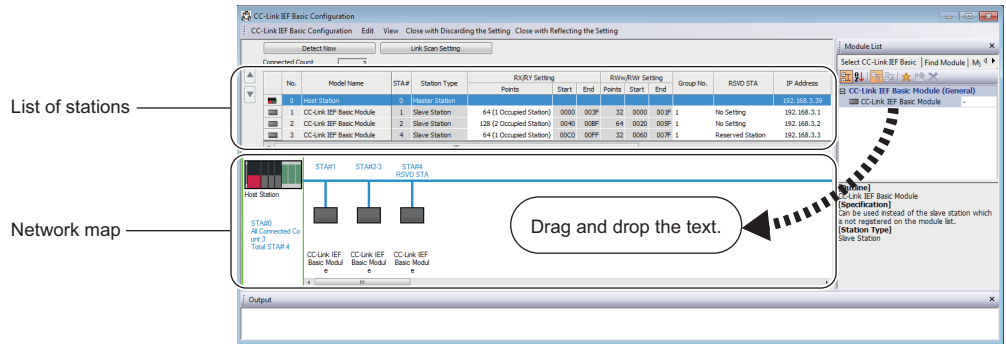

## Displayed items

Item	Description	Setting range	Default
[Detect Now] button	Connected devices are automatically detected. (☞ Page 38 Automatic detection of connected device)	—	—
[Link Scan Setting] button	Configure link scan settings. (☞ Page 41 Link Scan Setting)	—	—
Connected Count	The total number of connected slave stations is displayed.	—	—
No.	The station number of the slave station is displayed.	—	—
Model Name	Module model name is displayed. When there is no module information, "Module With No Profile Found" is displayed.	—	—
STA#	The start station number of the slave station is displayed.	—	—
Station Type	The station type (master station/slave station) is displayed.	—	—
RX/Ry Setting	Points	Set the assignment of the number of points for RX/Ry in increments of 64 points. • 64 (1 Occupied Station) • 128 (2 Occupied Station) • 192 (3 Occupied Station) • 256 (4 Occupied Station)	64 (1 Occupied Station)
	Start	The start number of RX/Ry is displayed.	—
	End	The end number of RX/Ry is displayed.	—
RWw/RWr Setting	Points	The number of points for the number of stations in increments of 32 points is displayed.	—
	Start	The start number of RWw/RWr is displayed.	—
	End	The end number of RWw/RWr is displayed.	—
Group No.	Set group numbers of slave stations.	1 to 4 <sup>*1</sup>	1
RSVD STA	Set whether to set the slave station as a reserved station.	• No Setting • Reserved Station	No Setting
IP Address	Specify the IP address of the slave station.	0.0.0.1 to 223.255.255.254	• First to third octet: first to third octet of the IP address of the master station • Fourth octet: automatically numbered from the number not in use from 1 to 254 in ascending order
Subnet Mask	Specify the subnet mask of the slave station.	0.0.0.1 to 255.255.255.255	Subnet mask of the master station
MAC Address	The MAC address of the slave station is displayed.	—	—
Comment	The information entered in "Comment1" on the "Properties" window displayed by right-clicking the module in the list of stations or the network map is displayed.	Up to 32 one-byte characters/16 two-byte characters	(Empty)

\*1 Groups do not need to be numbered serially. For example, setting group No.2 only (number of groups: one) and setting group No.1 and No.3 (number of groups: two) are both possible.  
For the CPU module that does not support the group number setting function, however, group No. is fixed to 1. (☞ Page 64 Added and Enhanced Functions)

## ■ Automatic detection of connected device

Actually connected slave stations are detected and reflected in the network configuration setting.

In the network configuration setting, communication settings such as IP addresses and subnet masks can be configured for the detected slave stations.

Parameters that are inherent in the slave stations can also be read/written from/to the network configuration setting. (Some slave stations do not support these features.)

Various settings of all slave stations can be configured in parameters of the master station (the settings do not need to be configured in each individual slave station) and therefore the man-hour for the setting will be reduced.

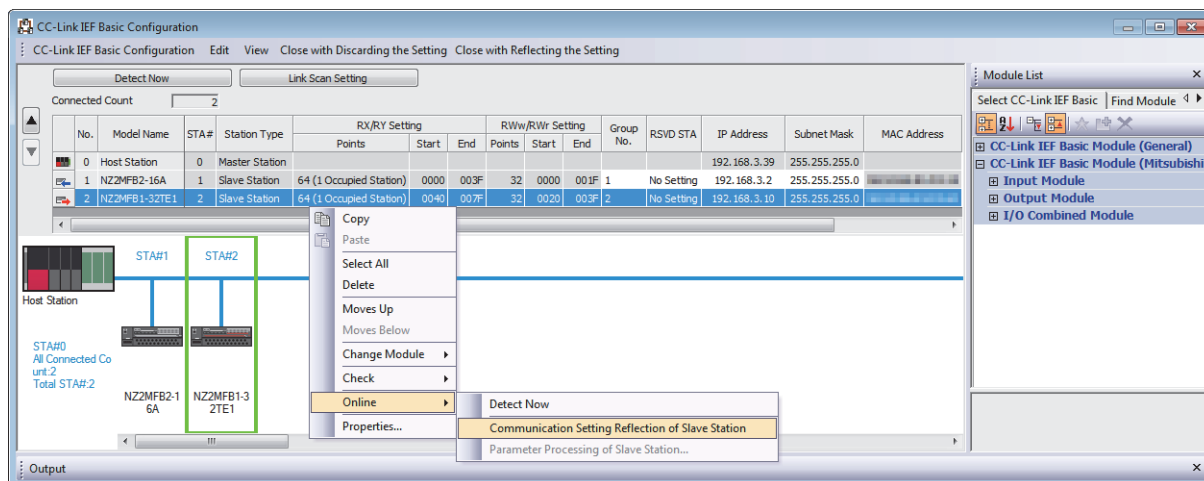

Follow the operating procedure below to use the automatic detection of connected device.

1. Start up a new project in GX Works3/GX Works2 and execute the automatic detection of connected device.
  2. Detected slave stations are reflected in the network configuration setting. Change the items such as the connection order and numbers of occupied stations and set station numbers.
  3. Configure IP addresses and subnet masks of slave stations in the network configuration setting. And then, reflect the settings to the slave stations.
- ☞ Select a module on the list of stations or the network map ⇒ [Online] ⇒ [Communication Setting Reflection of Slave Station]
4. Parameters that are inherent in the slave stations can be read/written from/to the network configuration setting.\*1 For details on the parameters inherent in each slave station, refer to the manuals of the slave station used.
- ☞ Select a module on the list of stations or the network map ⇒ [Online] ⇒ [Parameters Processing of Slave Station]
- \*1 To read parameters, select "Parameter read" from "Method selection" and click the [Execute] button. Parameters read are displayed in the column of "Read Value". To write parameters, select "Parameter write" from "Method selection", input data to the column of "Write Value", and then click the [Execute] button.

### Point

Slave station settings in the network configuration setting must be configured after executing the automatic detection of connected device.

If not, contents of setting items that have been already configured in the network configuration setting are overwritten by ones detected by the automatic detection. Detected slave stations are reflected in the network configuration setting in ascending order of MAC address and values such as the number of occupied stations becomes initial value.



If an error occurs while the automatic detection of connected device is being executed, the window shown below appears.

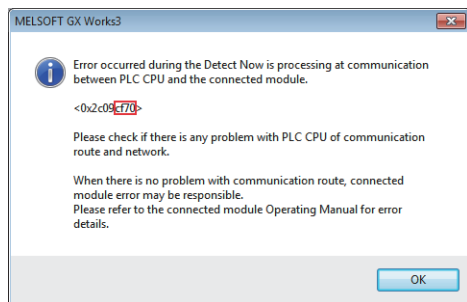

Each of the error codes listed below fills the last four digits of <0x2c09\*\*\*\*>.

Error code	Error details and cause	Action
480CH	The specified command cannot be executed because the automatic detection of connected device is being executed.	After the automatic detection of connected devices is completed, execute the command again.
480DH	<ul style="list-style-type: none"> <li>The specified command cannot be executed because the communication setting reflection of slave station is being executed.</li> <li>Communication timeout has occurred.</li> </ul>	<ul style="list-style-type: none"> <li>After the communication setting reflection of slave station is completed, execute the command again.</li> <li>Check and correct the communication time check setting value using the engineering tool.</li> </ul>
480EH	<ul style="list-style-type: none"> <li>The specified command cannot be executed because the parameters processing of slave station is being executed.</li> <li>Communication timeout has occurred.</li> </ul>	<ul style="list-style-type: none"> <li>Execute the command again after a while.</li> <li>Check and correct the communication time check setting value using the engineering tool.</li> </ul>
CF53H and CF56H	System error	<ul style="list-style-type: none"> <li>Check the precautions for the function executed.</li> <li>Check the operating status and connection status of the target device.</li> <li>Check the connection of an Ethernet cable and a hub.</li> <li>Check the line status of Ethernet.</li> <li>Reset the CPU module and target device, and execute the function again.</li> </ul> If the above actions do not solve the problem, contact the manufacturer of the target device.
C059H	The function which is not supported by the target device was executed.	Check whether the function executed is supported by the target device.
C05CH	<ul style="list-style-type: none"> <li>The setting value of the communication setting is out of range.</li> <li>Items of communication setting which cannot be set on the target device are set.</li> <li>The required setting items have not been set to the target device.</li> </ul>	Correct the setting details, and retry the operation.
C061H	System error	<ul style="list-style-type: none"> <li>Check the precautions for the function executed.</li> <li>Check the operating status and connection status of the target device.</li> <li>Check the connection of an Ethernet cable and a hub.</li> <li>Check the line status of Ethernet.</li> <li>Reset the CPU module and target device, and execute the function again.</li> </ul> If the above actions do not solve the problem, contact the manufacturer of the target device.
CEE0H	The detection or another online function was executed by another peripheral.	Execute the other function after the automatic detection of connected devices is completed.
CEE1H and CEE2H	System error	<ul style="list-style-type: none"> <li>Check the precautions for the function executed.</li> <li>Check the operating status and connection status of the target device.</li> <li>Check the connection of an Ethernet cable and a hub.</li> <li>Check the line status of Ethernet.</li> <li>Reset the CPU module and target device, and execute the function again.</li> </ul> If the above actions do not solve the problem, contact the manufacturer of the target device.
CF10H	System error	<ul style="list-style-type: none"> <li>Check the precautions for the function executed.</li> <li>Check the operating status and connection status of the target device.</li> <li>Check the connection of an Ethernet cable and a hub.</li> <li>Check the line status of Ethernet.</li> <li>Reset the CPU module and target device, and execute the function again.</li> </ul> If the above actions do not solve the problem, contact the manufacturer of the target device.
CF20H	<ul style="list-style-type: none"> <li>The setting value of the communication setting is out of range.</li> <li>Items of communication setting which cannot be set on the target device are set.</li> <li>The required setting items have not been set to the target device.</li> </ul>	Correct the setting details, and retry the operation.
CF30H	The parameter which is not supported by the target device was specified.	Check the version of the target device.

Error code	Error details and cause	Action
CF31H	System error	<ul style="list-style-type: none"> <li>• Check the precautions for the function executed.</li> <li>• Check the operating status and connection status of the target device.</li> <li>• Check the connection of an Ethernet cable and a hub.</li> <li>• Check the line status of Ethernet.</li> <li>• Reset the CPU module and target device, and execute the function again.</li> </ul> If the above actions do not solve the problem, contact the manufacturer of the target device.
CF50H	System error	<ul style="list-style-type: none"> <li>• Check the precautions for the function executed.</li> <li>• Check the operating status and connection status of the target device.</li> <li>• Check the connection of an Ethernet cable and a hub.</li> <li>• Check the line status of Ethernet.</li> <li>• Reset the CPU module and target device, and execute the function again.</li> </ul> If the above actions do not solve the problem, contact the manufacturer of the target device.
CF51H	The function cannot be executed because the function from another peripheral is being executed.	Execute the function again after a while.
CF53H to CF56H	System error	<ul style="list-style-type: none"> <li>• Check the precautions for the function executed.</li> <li>• Check the operating status and connection status of the target device.</li> <li>• Check the connection of an Ethernet cable and a hub.</li> <li>• Check the line status of Ethernet.</li> <li>• Reset the CPU module and target device, and execute the function again.</li> </ul> If the above actions do not solve the problem, contact the manufacturer of the target device.
CF70H	An error has occurred on the Ethernet communication path.	<ul style="list-style-type: none"> <li>• Check the operation of the target device.</li> <li>• Check if the connection cable is disconnected.</li> </ul>
CF71H	Timeout error	<ul style="list-style-type: none"> <li>• Check the precautions for the function executed.</li> <li>• Check the operation of the target device.</li> <li>• Since there may be congestion of packets on the line, send data after a certain period of time.</li> </ul>

## ■ Link Scan Setting

Set timeout time and number of retries for slave station disconnection detection.

### Window

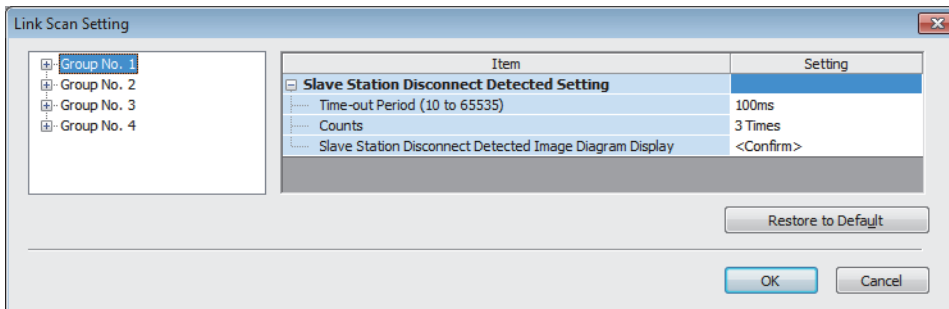

### Displayed items

Item	Description	Setting range	Default	
Slave Station Disconnect Detected Setting	Time-out Period (10 to 65535)	Set the timeout time (ms) for slave station disconnection detection. *2(☞ Page 24 Data flow of cyclic transmission)	10 to 65535*1	100*4
	Counts	Set the number of retries for slave station disconnection detection.*2*3	3, 5, 10	3
	Slave Station Disconnect Detected Image Diagram Display	The operation image regarding the slave station disconnection detection period is displayed. Refer to this at the setting of "Time-out Period".	—	—

\*1 Setting range of MELSEC iQ-F is 20 to 65535.

\*2 Timeout time and the number of times for disconnection detection are counted for each slave station.

\*3 Disconnection occurs in the event that no response is received from the slave station for the specified number of times in succession within the timeout time.

\*4 In GX Works3 with version earlier than "1.035M" or GX Works2 with version earlier than "1.565P", the default value is 500.

#### Point

- For setting of timeout time, specify an adequate value according to the actual system used. (☞ Page 25 No response received from a slave station)
- Time-out Period and Counts can be set for each group.

## Refresh Settings

Set refresh parameters.

### Window

Link Side					CPU Side				
Device Name	Points	Start	End		Target	Device Name	Points	Start	End
RX				↔					
RY				↔					
RWr				↔					
RWw				↔					

### Displayed items

Item	Description	Setting range	Default
Link Side	The number of points for the link devices (RX/RX, RWr/RWw) for the number of occupied stations and start/end device number set in the network configuration settings are displayed.	—	—
CPU Side	Target	The target destination to be link refreshed is displayed.	Specify Device
	Device Name	Set the device of the link refresh target.	X, Y, M, L, B, D, W, R, ZR <sup>*1</sup> , RD <sup>*1</sup>
	Points	The number of device points for the link refresh target is displayed. (The same value as the number of points on the link side is displayed.)	—
	Start	Set the start device number within the link refresh range.	Follow the device settings of the CPU parameters. (See Each user's manual)
	End	The end device number within the link refresh range is displayed.	—

\*1 These devices cannot be set for MELSEC iQ-F series modules.

# 8.2 Settings for MELSEC-Q/MELSEC-L

Use GX Works2 for master station settings.

## CC-Link IEF Basic settings

### IP address settings

To display the "CC-Link IEF Basic Setting" window, set "IP Address", "Subnet Mask Pattern", and "Default Router IP Address" in the "IP Address Setting" window in advance.

After that, click the [CC-Link IEF Basic Setting] button and the "CC-Link IEF Basic Setting window" appears.

 [Project window] ⇒ [Parameter] ⇒ [PLC Parameter] ⇒ [Built-in Ethernet Port Setting] tabs

### Window

### Displayed items

Item	Setting range
IP Address	0.0.0.1 to 223.255.255.254
Subnet Mask Pattern	0.0.0.1 to 255.255.255.255 When there is no value to set, any one of the following recommended values. <ul style="list-style-type: none"> <li>• 255.0.0.0 (For the IP address whose first octet is 127 or less)</li> <li>• 255.255.0.0 (For the IP address whose first octet is between or equal to 128 and 191)</li> <li>• 255.255.255.0 (For the IP address whose first octet is 192 or greater)</li> </ul>
Default Router IP Address	0.0.0.1 to 223.255.255.254 When there is no value to set, use an IP address that is not used for the network.

**Ex.**

## CC-Link IEF Basic settings

This section describes how to configure whether to use CC-Link IE Field Network Basic and the settings of the refresh parameters.

### Window

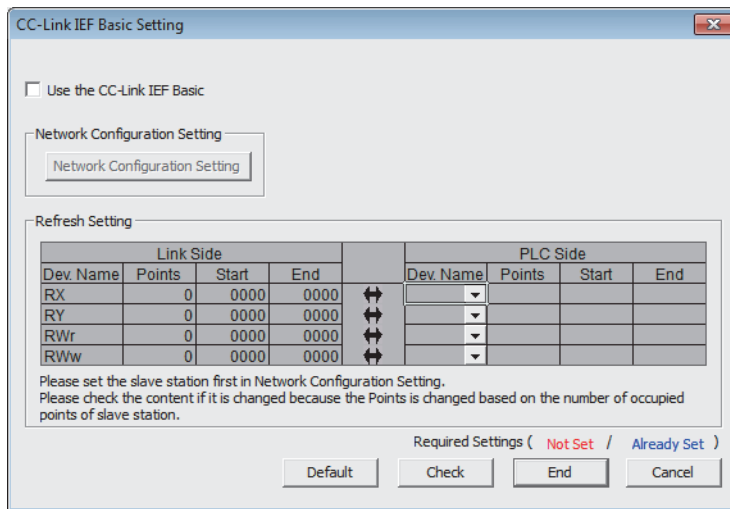

### Displayed items

Item	Description	Setting range	Default	
Use the CC-Link IEF Basic	Set whether to use CC-Link IE Field Network Basic.	<ul style="list-style-type: none"> <li>• Checked</li> <li>• Unchecked</li> </ul>	Unchecked	
Network Configuration Settings	[Network Configuration Settings] button Set the information of the slave station to the master station. Setting items are the same as GX Works3. (Page 37 Network Configuration Settings)	—	—	
Refresh Settings	Link Side	The number of points for the link devices (RX/RY, RWr/RWw) for the number of occupied stations and start/end device number set in the network configuration settings are displayed.	—	
	CPU Side	Device Name	Set the device of the link refresh target.	X, Y, M, L, B, D <sup>*1</sup> , W <sup>*1</sup> , R, ZR (Empty)
		Points	The number of device points for the link refresh target is displayed. (The same value as the number of points on the link side is displayed.)	—
		Start	Set the start device number within the link refresh range.	Follow the device settings of the CPU parameters. (Empty)
		End	The end device number within the link refresh range is displayed.	—

\*1 Extended data register (D) and extended link register (W) are also included.

## 8.3 Settings for MELIPC

---

Refer to the following.

 MELIPC MI5000 Series User's Manual (Application)

# 9 TROUBLESHOOTING

---

This chapter describes troubleshooting of CC-Link IE Field Network Basic.

When the MELIPC is used, refer to the following.

 MELIPC MI5000 Series User's Manual (Application)

## 9.1 CC-Link IE Field Network Basic Diagnostics

---

Perform troubleshooting by executing the CC-Link IE Field Network Basic diagnostics and checking the network status and error details.

When the C Controller module is used, refer to the following.

 MELSEC iQ-R C Controller Module User's Manual (Application)

When the FX5-ENET is used, refer to the following.

 MELSEC iQ-F FX5-ENET User's Manual

### How to execute diagnostics

---

Execute the CC-Link IE Field Network Basic diagnostics, following the procedure below.

- 1.** Connect GX Works3/GX Works2 to the CPU module on the master station.
- 2.** Start the CC-Link IE Field Network Basic diagnostics.

 [Diagnostics] ⇒ [CC-Link IEF Basic Diagnostics]





## Displayed items

Item	Description
Total Slave (Parameter)	The total number of slave stations set in parameter is displayed.
IP Address	The IP address of the master station is displayed. The display can be switched between decimals and hexadecimals in "Change IP Address Display".
Error Code	The error code of the master station is displayed.
[Error Details] button	The description of the error and the actions to be taken are displayed.
Link Scan Time/Error Stations	Link scan time (present, maximum, minimum) and number of error stations/unfixed stations of each group is displayed. Error stations (Error Stns) and unfixed stations (Unfixed Stns) refers the following state. <ul style="list-style-type: none"> <li>• Error Stns: Stations where an error has been occurred</li> <li>• Unfixed Stns: Stations (not including reserved stations) where the transmission status has not been fixed</li> </ul>
Diagnostics Target Group	Select a group to display its diagnostic information list.
Station No.	The station number of the slave station is displayed.
Occpd Stns	The number of occupied stations set in parameter is displayed.
Reserved Station	The reserved station status set in parameter is displayed.
IP Address	The IP address set in parameter is displayed. "-" is displayed when the station is a reserved station and an IP address has not been set.
Transmission Status	The transmission status of the slave station is displayed. <ul style="list-style-type: none"> <li>• Unfixed: Communications with the master station not established<sup>*1</sup></li> <li>• Transmitting: Cyclic transmission being performed</li> <li>• Disconnecting: Disconnected from the master station</li> </ul>
Disconnections	The accumulated number of disconnection detection is displayed. <ul style="list-style-type: none"> <li>• 0: No disconnections</li> <li>• 1 to 65535: Number of disconnection detection (accumulated number)<sup>*3</sup></li> </ul>
Time-out Count	The accumulated number of timeouts is displayed. <ul style="list-style-type: none"> <li>• 0: No timeouts</li> <li>• 1 to 65535: Number of timeouts (accumulated number)<sup>*3</sup></li> </ul>
The Latest Error	The latest error code <sup>*4</sup> is displayed an error on the transmission status between the master station and slave stations detected by the master station or an error which has occurred in a slave station. When the slave station is disconnected, an error occurs. After that, even when the disconnected slave station returns to the system, the error is held. When another error occurs, the latest error will be updated (overwritten). When both errors occur, the priority of errors to be displayed is as follows. (1) An error which has occurred in a slave station (2) An error on the transmission status between the master station and slave stations detected by the master station For an error of the slave station, check 'Diagnostic information 2' (Un\G1068 to Un\G1077). (🔍 Page 52 Acquiring diagnostic information of slave stations)
Error Details...	The description of the error and the actions to be taken are displayed.
[Clear Latest Error Code] button	The error code is cleared. <sup>*2</sup> The button can be clicked only during monitoring.

\*1 The possible reasons include that the slave station set in parameter has not started up, a cable between the master station and the slave station is disconnected, or the setting of an IP address or a subnet mask of the master/slave station is incorrect.

\*2 Take actions and eliminate the error cause first. Then, clear the error code.

\*3 When the count exceeds 65535, counting is continued from 1 again.

\*4 For details on an error of the slave station, GX Works3 of "1.040S" or later supports. (🔍 Page 64 Added and Enhanced Functions)

### Point

For the error codes, refer to the manuals of each series.

📖 MELSEC iQ-R CPU Module User's Manual (Application)

📖 MELSEC iQ-F FX5 User's Manual (Application)

📖 QCPU User's Manual (Hardware Design, Maintenance and Inspection)

📖 MELSEC-L CPU Module User's Manual (Hardware Design, Maintenance and Inspection)

### Point

The following indicates that the disconnection has occurred due to no cyclic transmission caused by the cable disconnection of the master station side. In this case, the previous cyclic transmission time (just before the disconnection) is displayed on the link scan time.

- "CFE8" is displayed as the latest error for all slave stations. (No response received from a slave station)
- "No Error" is displayed on the error code of the master station.

## 9.2 Troubleshooting by Symptom

This section describes the troubleshooting by symptom. If the CC-Link IE Field Network Basic diagnostics does not solve the problem, perform this troubleshooting.

When the FX5-ENET is used, refer to the following.

 MELSEC iQ-F FX5-ENET User's Manual

### When the transmission status is disconnected or unfixed

Check the following:

#### ■Ethernet

Check item	Action
Are the IP address and subnet mask of the master station/slave stations correctly set?	Check and correct the IP address and subnet mask of the master station/slave stations.
Is the IP address already in use? Is there any device having the same IP address as the master station/slave stations within the same network address?	Set a unique IP address to the master station/slave stations.
Is the same network address set to the master station and slave stations?	<ul style="list-style-type: none"> <li>• Check and correct the IP address and subnet mask so that the network addresses of the master station and slave stations match.</li> <li>• Check and correct the subnet mask of the master station and slave stations so that they match as normal values.</li> </ul>
Is an access blocked?	Check the security settings such as a firewall.
Is any access from slave stations blocked in "IP Filter Settings" of the master station.	Allow an access from the IP address of the corresponding slave station.
Before an error was detected, has any device on the line, such as the master station, slave station, or hub, been replaced with a device having the same IP address as that of the device before replacement?	Take either of the following actions: <ul style="list-style-type: none"> <li>• Wait until the ARP cache is updated. (The waiting time varies depending on the device.)*<sup>1</sup></li> <li>• Restart all devices on the line.</li> </ul>

\*1 Devices on Ethernet have a table of IP addresses and their corresponding MAC address, called the ARP cache. When a device on the line is replaced with a device having the same IP address, the MAC address in the ARP cache becomes different from that of the replaced device. This may cause incorrect data communications. The ARP cache is updated by resetting a device or after a certain time has elapsed. The time varies depending on the device.



#### ■CC-Link IE Field Network Basic

Check item	Action
Are the devices specified in the refresh settings for the master station correct?	Check and correct the refresh settings.
Are the devices specified in the refresh settings for the master station used in other applications?	Check the settings and programs for the master station/slave stations, and correct them if they are incorrect.

### When cyclic data cannot be read/written from/to the slave station correctly

Check the following:

#### ■CC-Link IE Field Network Basic

Check item	Action
Is a slave station specified as a reserved station in "Network Configuration Settings" of "Basic Settings" for the master station?	Cancel the reserved station setting. (  Page 35 PARAMETER SETTINGS)
Has the accumulated number of timeouts of the slave station considered abnormal been counted up? <sup>*1</sup>	Check the following and take actions.  Page 50 When a station is repeatedly disconnected and reconnected
Has the accumulated number of disconnection detection of the slave station considered abnormal been counted up? <sup>*1</sup>	

\*1 The accumulated number of timeouts and the accumulated number of disconnection detection can be checked in diagnostic information 1. For programs to acquire diagnostic information, refer to the following.

 Page 52 Acquiring diagnostic information of slave stations

## When a station is repeatedly disconnected and reconnected

Check the following:

### ■Ethernet

Check item	Action
Are the Ethernet cables inserted to each slot until they click?	<ul style="list-style-type: none"> <li>• Lock the Ethernet cables securely.</li> <li>• Check that the Ethernet cables are correctly connected to the external devices and hubs.</li> </ul>
Do the used cables conform to the Ethernet standard?	Check the specifications of the Ethernet cables used.
Is any Ethernet cable disconnected?	Replace the disconnected Ethernet cable.
Is there any source of noise near the Ethernet cables? <sup>*1</sup>	Keep the Ethernet cables away from the source of noise. Or, use the cables resistant to noise.
Are there any external devices or hubs having an error? Or, is there any lost packet? <sup>*2</sup>	<ul style="list-style-type: none"> <li>• Reduce the number of cascade connections to three or less.</li> <li>• Take actions, referring to the manual for the device having an error or packet loss.<sup>*3</sup></li> </ul>
Is a correct hub, which is compatible with the communication speed of the connected master station/slave stations, used?	Replace the hub with a correct one.
Is the response of built-in Ethernet functions such as FTP, socket communications, and SLMP communications slow, an error, or not returned? <sup>*4</sup>	<ul style="list-style-type: none"> <li>• Stop the function. Or, modify settings. For example, extend the execution interval and decrease the execution frequency of the function.</li> <li>• Change UDP/IP communications to TCP/IP communications, or add resend processing.</li> </ul>

\*1 Check the communication status of Ethernet by referring to the areas for storing such as the CRC error count and the received packet checksum error discard count. For details, refer to the manuals of each series.

\*2 If the load is heavy, data communications may stop depending on the hub. In that case, consult the manufacturer of the device used.

\*3 When a personal computer and CPU module have been reconnected to the switching hub, or the switching hub has been replaced, it may take some time to read the MAC address. In this case, retry the transmission later or power on the hub again.

\*4 Check the communication status of Ethernet by referring to the areas for storing such as the simultaneous transmission error detection count and the number of times that data are not read due to receive buffer full. For details, refer to the manuals of each series.

### ■CC-Link IE Field Network Basic

Check item	Action
Is the timeout time setting of the master station too short?	Increase the timeout time of the master station.
Are there any slave stations having an error?	Perform troubleshooting for the slave station having an error.
Is CC-Link IE Field Network Basic being simultaneously executed at a different network address on the same line?	Separate the network and configure two CC-Link IE Field Network Basic lines.
Are data communications with other Ethernet devices being performed on the same line?	Separate the network for other Ethernet devices from the CC-Link IE Field Network Basic line and configure the CC-Link IE Field Network Basic line.
Is any of the following function being executed? <ul style="list-style-type: none"> <li>• Access from GX Works3/GX Works2 (such as ladder monitor)</li> <li>• Latch function</li> <li>• Data logging function</li> </ul>	Stop the function. Or, modify settings. For example, extend the execution interval, decrease the execution frequency, or reduce the range of the function.
Are slave stations divided into too many groups?	Reduce the number of groups as much as possible (for example, organizing slave stations of 16 or less into one group).
Is a slave station that the response is slow belonged to a group of shorter link scan time? Or, is a slave station that the response is fast belonged to a group of longer link scan time?	Refer to manuals for slave stations used to check their reference response times. Check and correct the group number of the corresponding slave station in the network configuration setting.

## When the link scan time delays

Refer to the following.

☞ Page 50 When a station is repeatedly disconnected and reconnected

## When access to the CPU module is slow

Check the following (especially when an error is returned or a response is not returned):

Check item	Action
Is any of the following function being executed? • Access from GX Works3/GX Works2 (such as ladder monitor) • Latch function • Data logging function	Stop the function. Or, modify settings. For example, extend the execution interval, decrease the execution frequency, or reduce the range of the function.
Is the response of built-in Ethernet functions such as FTP, socket communications, and SLMP communications slow, an error, or not returned? <sup>*1</sup>	• Stop the function. Or, modify settings. For example, extend the execution interval and decrease the execution frequency of the function. • Change UDP/IP communications to TCP/IP communications, or add resend processing.
Is CC-Link IE Field Network Basic being simultaneously executed at a different network address on the same line?	Separate the network and configure two CC-Link IE Field Network Basic lines.
Are data communications with other Ethernet devices being performed on the same line?	Separate the network for other Ethernet devices from the CC-Link IE Field Network Basic line.

\*1 Check the communication status of Ethernet by referring to the areas for storing such as the simultaneous transmission error detection count and the number of times that data are not read due to receive buffer full. For details, refer to the manuals of each series.

## When cyclic transmission of the master station stops

Check the following:

Check item	Action
Is the transmission status of slave stations normal?	• If there are any disconnected slave stations, take actions according to the error details. • If there are no disconnected slave stations, check the network connection. A problem may stem from a device other than those set in the master station.

## 9.3 Acquiring diagnostic information of slave stations

If an error occurs in a slave station or the cyclic data cannot be read or written correctly, the status of each slave station by executing a program for acquiring diagnostic information of slave stations can be checked.

When the C Controller module is used, refer to the following.

📖 MELSEC iQ-R C Controller Module User's Manual (Application)

### How to acquire diagnostic information

Acquire diagnostic information using the special relay (SM)/special register (SD)/buffer memory. (📖 Page 58 List of SM/SD/Buffer Memory Areas for CC-Link IE Field Network Basic)

1. Set the information acquisition target station number in 'Diagnostic request information' (Un\G1051).
2. Turn on 'Diagnostic information display request' (Un\G1050.0). Diagnostic information is stored in 'Diagnostic information 1' (Un\G1053 to Un\G1064) and 'Diagnostic information 2' (Un\G1068 to Un\G1077). ('Diagnostic information display request' (Un\G1050.0) turns off when diagnostic information is stored.)

### Program for acquiring diagnostic information

Use the following program to acquire diagnostic information.

#### MELSEC iQ-R, MELSEC iQ-L, MELSEC iQ-F

A program example created by GX Works3 is provided below.

#### ■Program for acquiring diagnostic information

Store the diagnostic information acquisition target station number in D0 and turn on M0. Diagnostic information 1 is transferred and stored in the area starting from D100 and diagnostic information 2 is transferred and stored in the area starting from D115 by the function block for diagnostic information acquisition (Slave station diagnostics).

- Devices used in the program

Device	Data type	Description
D0	Word	Information acquisition target station number
M0	Bit	A flag for starting diagnostic information acquisition processing
M1	Bit	A flag that indicates the acquisition processing is being performed
D100	Word	A start device for storing diagnostic information 1
D115	Word	A start device for storing diagnostic information 2

- Program example

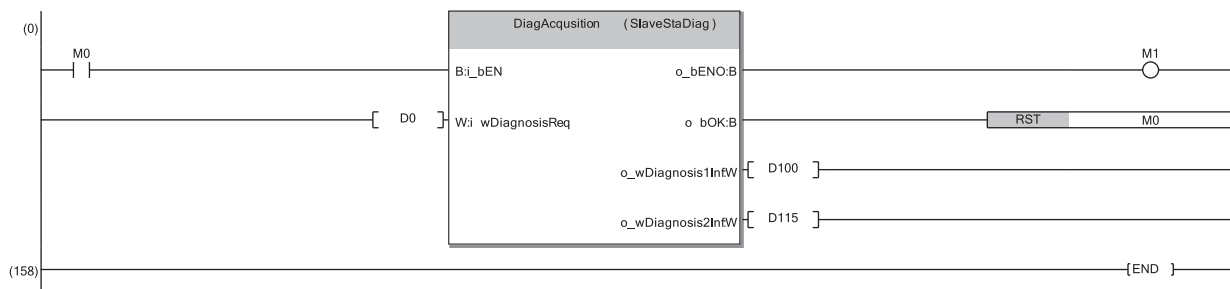

## ■Function block (FB) for diagnostic information acquisition (Slave station diagnostics)

Store the diagnostic information acquisition target station number in the diagnostic request information and turn on the diagnostic information display request. Diagnostic information 1 and 2 is transferred when the request flag turns off.

- Labels to be defined (details on FB inputs and outputs)

Label Name	Data Type	Class
i_bEN	Bit	VAR_INPUT
i_wDiagnosisReq	Word [Signed]	VAR_INPUT
o_bENO	Bit	VAR_OUTPUT
o_bOK	Bit	VAR_OUTPUT
o_wDiagnosis1Inf	Word [Signed]	VAR_OUTPUT
o_wDiagnosis2Inf	Word [Signed]	VAR_OUTPUT

Label name	Description
i_bEN	A trigger (on input) for starting diagnostic information acquisition processing
i_wDiagnosisReq	A value stored in the diagnostic request information. Enter the information acquisition target station number.
o_bENO	A flag that indicates the acquisition processing is being performed. The on status indicates that the processing is being performed.
o_bOK	A flag that indicates the acquisition processing has completed
o_wDiagnosis1Inf	A start device for storing diagnostic information 1. Diagnostic information 1, for 15 words starting from the specified device, is stored.
o_wDiagnosis2Inf	A start device for storing diagnostic information 2. Diagnostic information 2, for 16 words starting from the specified device, is stored.

- Module labels used in the program

Series	Module label	Description	Device
MELSEC iQ-R	RCPU.stB.bDiag_Request	Diagnostic information display request	Un\G1050.0
	RCPU.stB.uInformation_Diag_Request	Diagnostic request information	Un\G1051
	RCPU.stB.stDiag1.uNumber_Occupied_Stations	Number of occupied stations (start device of diagnostic information 1)	Un\G1053
	RCPU.stB.stDiag2.uVal_ManufacturerCode	Manufacturer code (start device of diagnostic information 2)	Un\G1068
MELSEC iQ-L	LHCPU.stB.bDiag_Request	Diagnostic information display request	Un\G1050.0
	LHCPU.stB.uInformation_Diag_Request	Diagnostic request information	Un\G1051
	LHCPU.stB.stDiag1.uNumber_Occupied_Stations	Number of occupied stations (start device of diagnostic information 1)	Un\G1053
	LHCPU.stB.stDiag2.uVal_ManufacturerCode	Manufacturer code (start device of diagnostic information 2)	Un\G1068
MELSEC iQ-F	FX5CPU.stB.bDiag_Request	Diagnostic information display request	SD11126.0
	FX5CPU.stB.uInformation_Diag_Request	Diagnostic request information	SD11127
	FX5CPU.stB.stDiag1.uNumber_Occupied_Stations	Number of occupied stations (start device of diagnostic information 1)	SD11129
	FX5CPU.stB.stDiag2.uVal_ManufacturerCode	Manufacturer code (start device of diagnostic information 2)	SD11144

- Program example

The following is a program example of MELSEC iQ-R series.

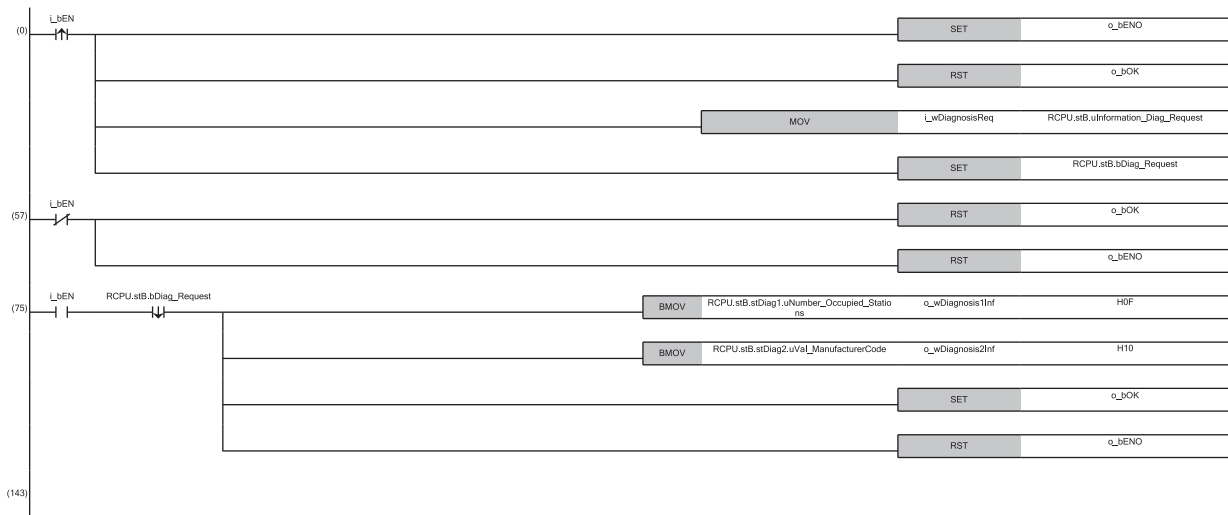

- (0) Check the on status of the diagnostic information display request and store the information acquisition target station number.
- (57) Check the off status of the diagnostic information display request.
- (75) Store diagnostic information 1 and diagnostic information 2.



## MELSEC-Q, MELSEC-L

A program example created by GX Works2 is provided below.

### ■ Program for acquiring diagnostic information

Store the diagnostic information acquisition target station number in D0 and turn on M0. Diagnostic information 1 is transferred and stored in the area starting from D100 and diagnostic information 2 is transferred and stored in the area starting from D115 by the function block for diagnostic information acquisition.

- Devices used in the program

Device	Data type	Description
D0	Word	Information acquisition target station number
M0	Bit	A flag for starting diagnostic information acquisition processing
M1	Bit	A flag that indicates the acquisition processing is being performed
D100	Word	A start device for storing diagnostic information 1
D115	Word	A start device for storing diagnostic information 2

- Program example

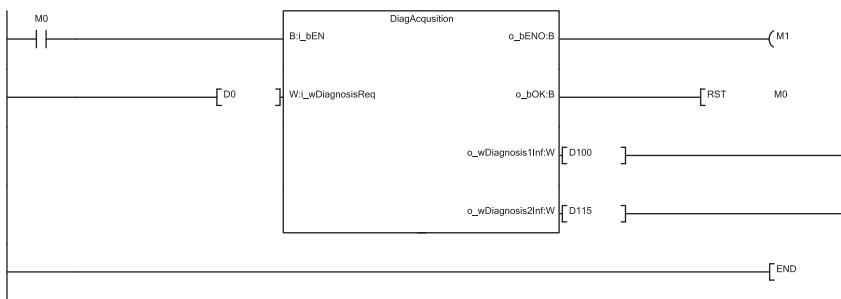

## ■Function block (FB) for diagnostic information acquisition

Store the diagnostic information acquisition target station number in the diagnostic request information and turn on the diagnostic information display request. Diagnostic information 1 and 2 is transferred when the request flag turns off.

- Labels to be defined (details on FB inputs and outputs)

Label name	Data type	Class	Description
i_bEN	Bit	VAR_INPUT	A trigger (on input) for starting diagnostic information acquisition processing
i_wDiagnosisReq	Word	VAR_INPUT	A value stored in the diagnostic request information. Enter the information acquisition target station number.
o_bENO	Bit	VAR_OUTPUT	A flag that indicates the acquisition processing is being performed. The on status indicates that the processing is being performed.
o_bOK	Bit	VAR_OUTPUT	A flag that indicates the acquisition processing has completed
o_wDiagnosis1Inf	Word	VAR_OUTPUT	A start device for storing diagnostic information 1. Diagnostic information 1, for 15 words starting from the specified device, is stored.
o_wDiagnosis2Inf	Word	VAR_OUTPUT	A start device for storing diagnostic information 2. Diagnostic information 2, for 16 words starting from the specified device, is stored.

- Devices used in the program

Device	Description
SM1741	Diagnostic information display request
SD1741	Diagnostic request information
SD1743	Number of occupied stations (start device of diagnostic information 1)
SD1758	Manufacturer code (start device of diagnostic information 2)

- Program example

The following is a program example of MELSEC-Q series.

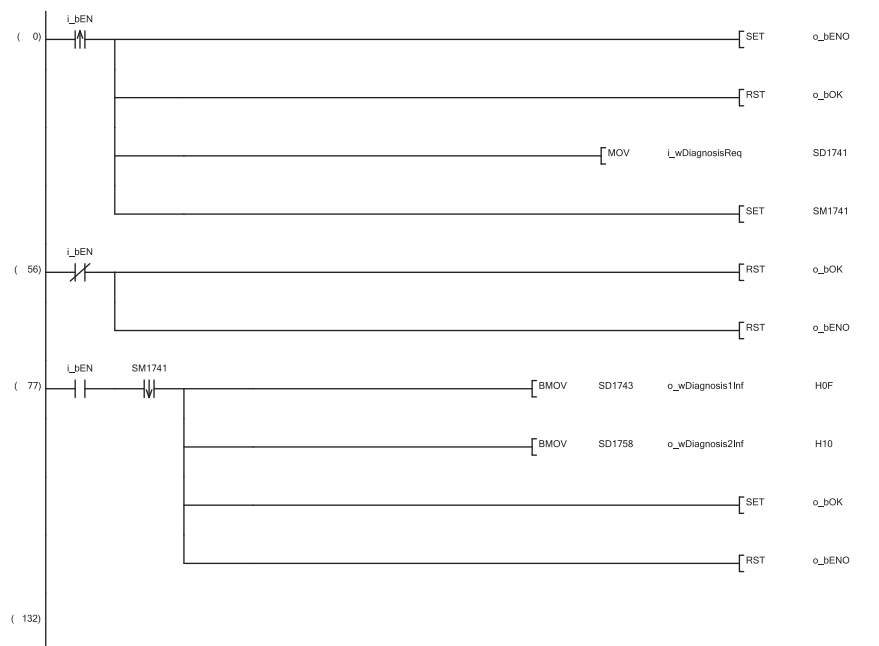

- (0) Check the on status of the diagnostic information display request and store the information acquisition target station number.  
 (56) Check the off status of the diagnostic information display request.  
 (77) Store diagnostic information 1 and diagnostic information 2.



# APPENDICES

## Appendix 1 List of SM/SD/Buffer Memory Areas for CC-Link IE Field Network Basic

The special relay (SM)/special register (SD) numbers and the buffer memory addresses for CC-Link IE Field Network Basic differ depending on the series of the programmable controller used. The following is the comparison table of the corresponding numbers and addresses.

When the FX5-ENET is used, refer to the following.

 MELSEC iQ-F FX5-ENET User's Manual

When the MELIPC is used, refer to the following.

 MELIPC MI5000 Series User's Manual (Application)

Name	Description	SM/SD/Buffer memory		
		MELSEC iQ-R, MELSEC iQ-L	MELSEC iQ-F	MELSEC-Q, MELSEC-L
Cyclic transmission status	This relay turns on when the cyclic transmission starts.	SM1536	SM1536	SM1700
Data link status	This relay turns on when an error exists even in one slave station.	SM1540	SM1540	SM1704
Reserved station specification status	The reserved station specification status of the slave station specified in parameter is stored.	Un\G1025.0	SD11101.0	SM1718
Diagnostic information display request	The bit is turned on to read the diagnostic information of the specified slave station.	Un\G1050.0	SD11126.0	SM1741
Cyclic transmission status of each station	The cyclic transmission status of each station is stored. (1 to 16 stations)	SD1536	SD1536	SD1700
	The cyclic transmission status of each station is stored. (17 to 32 stations)	SD1537	—	SD1701 <sup>*1</sup>
	The cyclic transmission status of each station is stored. (33 to 48 stations)	SD1538	—	SD1702 <sup>*1</sup>
	The cyclic transmission status of each station is stored. (49 to 64 stations)	SD1539	—	SD1703 <sup>*1</sup>
Data link status of each station	The data link status of each station is stored. (1 to 16 stations)	SD1540	SD1540	SD1704
	The data link status of each station is stored. (17 to 32 stations)	SD1541	—	SD1705 <sup>*1</sup>
	The data link status of each station is stored. (33 to 48 stations)	SD1542	—	SD1706 <sup>*1</sup>
	The data link status of each station is stored. (49 to 64 stations)	SD1543	—	SD1707 <sup>*1</sup>
Total number of connected stations	The total number of connected stations set in parameter is stored.	Un\G1024	SD11100	SD1716
Reserved station specification status of each station	The reserved station specification status is stored. (1 to 16 stations)	Un\G1026	SD11102	SD1718
	The reserved station specification status is stored. (17 to 32 stations)	Un\G1027	—	SD1719 <sup>*1</sup>
	The reserved station specification status is stored. (33 to 48 stations)	Un\G1028	—	SD1720 <sup>*1</sup>
	The reserved station specification status is stored. (49 to 64 stations)	Un\G1029	—	SD1721 <sup>*1</sup>





Name		Description	SM/SD/Buffer memory		
			MELSEC iQ-R, MELSEC iQ-L	MELSEC iQ-F	MELSEC-Q, MELSEC-L
Link scan information	Group No.1 maximum link scan time	The maximum link scan time value during cyclic transmission is stored. (Unit: ms)	Un\G1030	SD11106	SD1722
	Group No.1 minimum link scan time	The minimum link scan time value during cyclic transmission is stored. (Unit: ms)	Un\G1031	SD11107	SD1723
	Group No.1 current link scan time	The current link scan time value during cyclic transmission is stored. (Unit: ms)	Un\G1032	SD11108	SD1724
	Group No.2 maximum link scan time	The maximum link scan time value during cyclic transmission is stored. (Unit: ms)	Un\G1034	—	SD1726 <sup>*1</sup>
	Group No.2 minimum link scan time	The minimum link scan time value during cyclic transmission is stored. (Unit: ms)	Un\G1035	—	SD1727 <sup>*1</sup>
	Group No.2 current link scan time	The current link scan time value during cyclic transmission is stored. (Unit: ms)	Un\G1036	—	SD1728 <sup>*1</sup>
	Group No.3 maximum link scan time	The maximum link scan time value during cyclic transmission is stored. (Unit: ms)	Un\G1038	—	SD1730 <sup>*1</sup>
	Group No.3 minimum link scan time	The minimum link scan time value during cyclic transmission is stored. (Unit: ms)	Un\G1039	—	SD1731 <sup>*1</sup>
	Group No.3 current link scan time	The current link scan time value during cyclic transmission is stored. (Unit: ms)	Un\G1040	—	SD1732 <sup>*1</sup>
	Group No.4 maximum link scan time	The maximum link scan time value during cyclic transmission is stored. (Unit: ms)	Un\G1042	—	SD1734 <sup>*1</sup>
	Group No.4 minimum link scan time	The minimum link scan time value during cyclic transmission is stored. (Unit: ms)	Un\G1043	—	SD1735 <sup>*1</sup>
	Group No.4 current link scan time	The current link scan time value during cyclic transmission is stored. (Unit: ms)	Un\G1044	—	SD1736 <sup>*1</sup>
Diagnostic request information		The diagnostic information display target slave station is specified.	Un\G1051	SD11127	SD1741
Diagnostic information status flag		The diagnostic information status (valid or invalid) of the specified slave station is stored.	Un\G1052	SD11128	SD1742
Diagnostic information 1	Number of occupied stations	The number of occupied stations of the specified slave station is stored.	Un\G1053	SD11129	SD1743
	Group number	The group number of the specified slave station is stored.	Un\G1054	SD11130	SD1744
	IP address (lower)	The IP address (lower) of the specified slave station is stored.	Un\G1055	SD11131	SD1745
	IP address (upper)	The IP address (upper) of the specified slave station is stored.	Un\G1056	SD11132	SD1746
	Accumulated number of timeouts	The accumulated number of timeouts of the specified slave station is stored.	Un\G1063	SD11139	SD1753
	Accumulated number of disconnection detections	The accumulated number of disconnection detections of the specified slave station is stored.	Un\G1064	SD11140	SD1754

Name		Description	SM/SD/Buffer memory		
			MELSEC iQ-R, MELSEC iQ-L	MELSEC iQ-F	MELSEC-Q, MELSEC-L
Diagnostic information 2	Manufacturer code	The manufacturer code of the specified slave station is stored.	Un\G1068	SD11144	SD1758
	Model code (lower)	The model code (lower) of the specified slave station is stored.	Un\G1070	SD11146	SD1760
	Model code (upper)	The model code (upper) of the specified slave station is stored.	Un\G1071	SD11147	SD1761
	Device version	The device version of the specified slave station is stored.	Un\G1072	SD11148	SD1762
	Module information	The module information of the specified slave station is stored.	Un\G1074	SD11150	SD1764
	Error code	The code corresponding to the latest error occurred in the specified slave station is stored.	Un\G1075	SD11151	SD1765
	Detailed module information (lower)	The detailed module information (lower) of the specified slave station is stored.	Un\G1076	SD11152	SD1766
	Detailed module information (upper)	The detailed module information (upper) of the specified slave station is stored.	Un\G1077	SD11153	SD1767

\*1 These areas are not applicable to the MELSEC-L series CPU module.

**Point** 

For details on the special relay (SM), special register (SD), and buffer memory, refer to the following.

-  MELSEC iQ-R CPU Module User's Manual (Application)
-  Controller Module User's Manual (Application)
-  MELSEC iQ-F FX5 User's Manual (Application)
-  QCPU User's Manual (Hardware Design, Maintenance and Inspection)
-  MELSEC-L CPU Module User's Manual (Hardware Design, Maintenance and Inspection)

# Appendix 2 Processing Time

The processing time of CC-Link IE Field Network Basic consists of the time components below.

Sequence scan time + Link scan time + Slave station response processing time = Transmission delay time

When the C Controller module is used, refer to the following.

📖 MELSEC iQ-R C Controller Module User's Manual (Application)

When the MELIPC is used, refer to the following.

📖 MELIPC MI5000 Series User's Manual (Application)

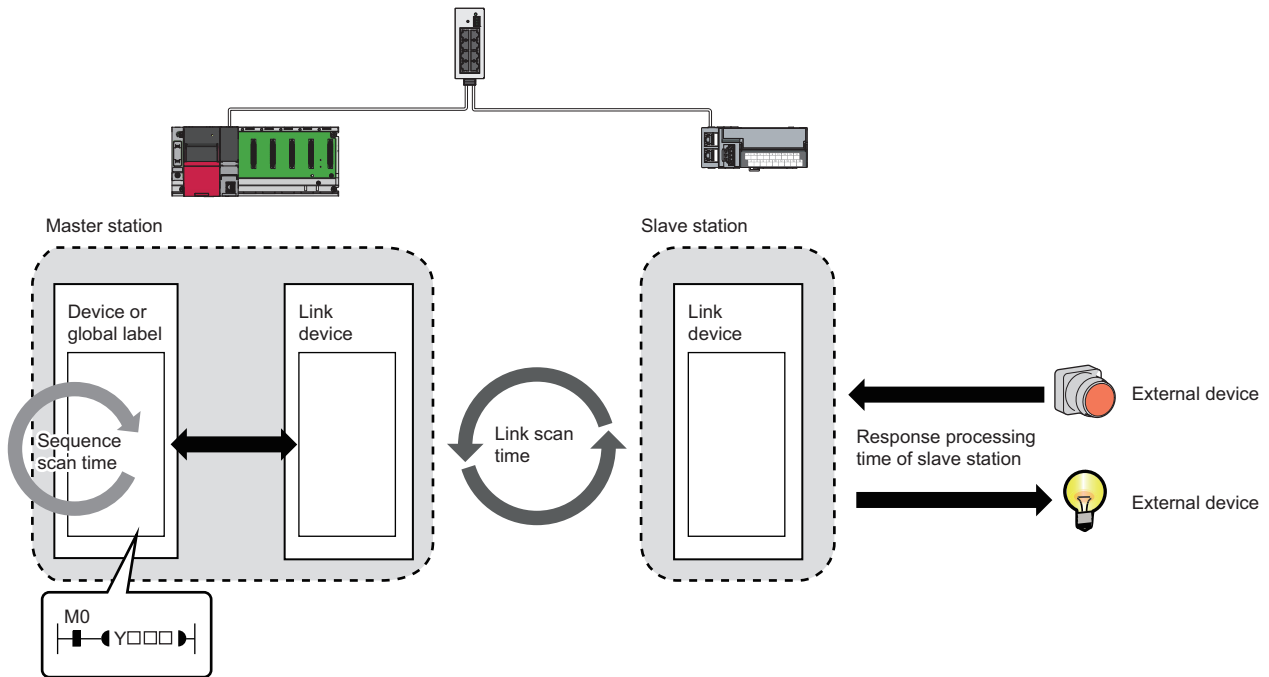

- Sequence scan time: Refer to the following.

📖 MELSEC iQ-R CPU Module User's Manual (Application)

📖 MELSEC iQ-F FX5 User's Manual (Application)

📖 QnUCPU User's Manual (Function Explanation, Program Fundamentals)

📖 MELSEC-L CPU Module User's Manual (Function Explanation, Program Fundamentals)

- Link scan time: 📖 Page 62 Link scan time
- Slave station response processing time: 📖 Manual for the slave station used
- Transmission delay time: 📖 Page 63 Transmission delay time

## Link scan time

Use the following formulas to calculate the link scan time.

### MELSEC iQ-R, MELSEC iQ-L, MELSEC-Q, MELSEC-L

Use the following formula to calculate the link scan time (Ls).

$$Ls^{*1} = Ns + Nm$$

$$Nm = KM1 + (KM2 \times (N - 1))$$

Item	Description
Ls	Link scan time [ms]
Ns	Processing time required for the slave station to respond to a request from the master station (reference response time) <sup>*2</sup> [ms]
Nm	Processing time required for the master station to send a request upon receiving a response from the slave station [ms]
N	Number of slave stations connected
KM1, KM2	Constant (  Page 62 Constant values)

\*1 When a timeout or disconnection has been detected, the timeout time set in the link scan setting parameter will be the link scan time. (  Page 25 No response received from a slave station)

\*2 The time indicates the reference response time of the slowest slave station among all of the connected slave stations. Note, however, that the timeout time set in parameter will be the processing time of the slave station when a timeout occurs.

### ■Constant values

The following table lists the constant values for each series.

Constant	Constant value			
	MELSEC iQ-R, MELSEC iQ-L	MELSEC-Q	MELSEC-L	
			L02CPU, L02CPU-P	L06CPU, L06CPU-P, L26CPU, L26CPU-P, L26CPU-BT, L26CPU-PBT
KM1	6.66	6.66	6.8	6.7
KM2	0.22 <sup>*1</sup>	0.22	0.42	0.38

\*1 When the number of connected slave stations increases, the value may be doubled (0.44) at most.

### MELSEC iQ-F

Use the following formula to calculate the link scan time (Ls).

$$Ls^{*1} = SM + n1$$

n1 = Value obtained by rounding up the calculated value of  $((Ns + Nm) \div SM)$  to the nearest whole number

Item	Description
Ls	Link scan time [ms]
SM	Sequence scan time [ms]
Ns	Processing time required for the slave station to respond to a request from the master station (reference response time) <sup>*2</sup> [ms]
Nm	Processing time required for the master station to send a request upon receiving a response from the slave station <sup>*3</sup> [ms]

\*1 When a timeout or disconnection has been detected, the timeout time set in the link scan setting parameter will be the link scan time. (  Page 25 No response received from a slave station)

\*2 The time indicates the reference response time of the slowest slave station among all of the connected slave stations. Note, however, that the timeout time set in parameter will be the processing time of the slave station when a timeout occurs.

\*3 The time depends on the processing time of programs. (  Page 30 MELSEC iQ-F)



# Transmission delay time

A transmission delay time includes an input transmission delay time and an output transmission delay time.

## Input transmission delay time

The input transmission delay time means the following.

- Time between when a signal (RX) is input to the slave station and when a device of the master station turns on or off
- Time between data (RW<sub>r</sub>) is input to the slave station and when the data is stored in a device of the master station

### ■MELSEC iQ-R, MELSEC iQ-L, MELSEC-Q, MELSEC-L

Input transmission delay time (maximum) =  $SM + Ls \times 2 + SS$  [ms]

Item	Description
SM	Sequence scan time [ms]
Ls	Link scan time [ms]
SS	Processing time required for the slave station to reflect the input [ms] (Manual for the slave station used)

### ■MELSEC iQ-F

Input transmission delay time (maximum) =  $SM + Ls + SS$  [ms]

Item	Description
SM	Sequence scan time [ms]
Ls	Link scan time [ms]
SS	Processing time required for the slave station to reflect the input [ms] (Manual for the slave station used)

## Output transmission delay time

The output transmission delay time means the following.

- Time between when a device of the master station turns on or off and when the output (RY) of the slave station turns on or off
- Time between when data is set to a device of the master station and when the data (RW<sub>w</sub>) is output to the slave station

### ■MELSEC iQ-R, MELSEC iQ-L, MELSEC-Q, MELSEC-L

Output transmission delay time (maximum) =  $SM + Ls + SS$  [ms]

Item	Description
SM	Sequence scan time [ms]
Ls	Link scan time [ms]
SS	Processing time required for the slave station to reflect the output [ms] (Manual for the slave station used)

### ■MELSEC iQ-F

Output transmission delay time (maximum) =  $Ls + SS$  [ms]

Item	Description
Ls	Link scan time [ms]
SS	Processing time required for the slave station to reflect the output [ms] (Manual for the slave station used)

# Appendix 3 Added and Enhanced Functions

This section shows added and enhanced functions of CC-Link IE Field Network Basic, as well as the software versions of GX Works3/GX Works2 and the firmware versions/serial numbers (first five digits) of the modules/devices that can be used as the master station that support those functions.

## MELSEC iQ-R

### ■R00CPU, R01CPU, R02CPU

Added or enhanced function	CPU module firmware version	GX Works3 software version	Reference
CC-Link IE Field Network Basic	"01" or later	"1.040S" or later	—
Error details information of the slave station in CC-Link IE Field Network Basic diagnostics	—		Page 46 CC-Link IE Field Network Basic Diagnostics

### ■Rn(EN)CPU (except for the R00CPU, R01CPU, and R02CPU)

Added or enhanced function	CPU module firmware version	GX Works3 software version	Reference
CC-Link IE Field Network Basic	"25" or later	"1.030G" or later	—
Group number setting	"28" or later	"1.035M" or later	Page 31 Group number setting
Automatic detection of connected device	—		Page 38 Automatic detection of connected device
Error details information of the slave station in CC-Link IE Field Network Basic diagnostics	—	"1.040S" or later	Page 46 CC-Link IE Field Network Basic Diagnostics

### ■C Controller module

For the C Controller module firmware version and CW Configurator software version, refer to the following.

 MELSEC iQ-R C Controller Module User's Manual (Application)

 CW Configurator Operating Manual

## MELSEC iQ-L

Added or enhanced function	CPU module firmware version	GX Works3 software version	Reference
CC-Link IE Field Network Basic	"01" or later	"1.060N" or later	—

## MELSEC iQ-F

### ■FX5U CPU module, FX5UC CPU module

Added or enhanced function	CPU module firmware version	GX Works3 software version	Reference
CC-Link IE Field Network Basic	"1.040" or later	"1.030G" or later	—
Automatic detection of connected device	—	"1.035M" or later	Page 38 Automatic detection of connected device
Error details information of the slave station in CC-Link IE Field Network Basic diagnostics	—	"1.040S" or later	Page 46 CC-Link IE Field Network Basic Diagnostics

### ■FX5UJ CPU module

Added or enhanced function	CPU module firmware version	GX Works3 software version	Reference
CC-Link IE Field Network Basic	"1.000" or later	"1.060N" or later	—
Automatic detection of connected device	—	"1.060N" or later	Page 38 Automatic detection of connected device
Error details information of the slave station in CC-Link IE Field Network Basic diagnostics	—	"1.060N" or later	Page 46 CC-Link IE Field Network Basic Diagnostics

### ■FX5-ENET

For the CPU module firmware version and GX Works3 software version that support the FX5-ENET, refer to the following.

 MELSEC iQ-F FX5 User's Manual (Application)

## MELSEC-Q

### ■QnUDVCPU, QnUDPVCPU

Added or enhanced function	CPU module serial number (first five digits)	GX Works2 software version	Reference
CC-Link IE Field Network Basic	"18112" or later	"1.555D" or later	—
Group number setting	"19042" or later	"1.565P" or later	Page 31 Group number setting
Automatic detection of connected device	—		Page 38 Automatic detection of connected device

## MELSEC-L

Added or enhanced function	CPU module serial number (first five digits)	GX Works2 software version	Reference
CC-Link IE Field Network Basic	"18112" or later	"1.555D" or later	—
Automatic detection of connected device	—	"1.565P" or later	Page 38 Automatic detection of connected device

## MELIPC

For the firmware version and MI Configurator software version of the MELIPC, refer to the following.

 MELIPC MI5000 Series User's Manual (Application)

 MI Configurator Operating Manual

# INDEX

---

## A

---

Access range . . . . .	16
Assignment range . . . . .	17

## E

---

Ethernet cable . . . . .	19
--------------------------	----

## H

---

Hub . . . . .	19
---------------	----

## I

---

IP address . . . . .	37
----------------------	----

## L

---

Link refresh . . . . .	27
Link scan . . . . .	29

## N

---

Network topology . . . . .	15
Number of link points . . . . .	17

## P

---

Program example . . . . .	21,22
---------------------------	-------

## R

---

Reserved station . . . . .	37
Reserved station specification . . . . .	34

## S

---

Station number . . . . .	17,37
Subnet mask . . . . .	37

# MEMO

---

# REVISIONS

\*The manual number is given on the bottom left of the back cover.

Revision date	*Manual number	Description
October 2016	SH(NA)-081684ENG-A	First edition
April 2017	SH(NA)-081684ENG-B	■Added or modified parts Section 2.1, Chapter 3, 4, Section 7.1, 8.1, 9.1, 9.2, Appendix 1, 2, 3
October 2017	SH(NA)-081684ENG-C	■Added or modified parts Section 2.1, Chapter 3, Section 5.2, Chapter 6, 7, Section 8.1, 9.1, 9.3, Appendix 1, 2, 3
May 2018	SH(NA)-081684ENG-D	■Added or modified parts SAFETY PRECAUTIONS, CONDITIONS OF USE FOR THE PRODUCT, INTRODUCTION, TERMS, Section 1.1, 2.1, Chapter 3, 4, Section 5.1, 5.2, Chapter 6, 7, Section 8.3, Chapter 9, Appendix 1, 2, 3
October 2019	SH(NA)-081684ENG-E	■Added or modified parts Section 2.1, Chapter 3, 4, Section 5.2, Chapter 6, Section 6.1, Chapter 7, Section 7.1, Chapter 8, Section 8.1, 8.2, Chapter 9, Section 9.3, Appendix 1, 2, 3

Japanese manual number: SH-081683-E

This manual confers no industrial property rights of any other kind, nor does it confer any patent licenses. Mitsubishi Electric Corporation cannot be held responsible for any problems involving industrial property rights which may occur as a result of using the contents noted in this manual.

© 2016 MITSUBISHI ELECTRIC CORPORATION

# WARRANTY

---

Please confirm the following product warranty details before using this product.

## **1. Gratis Warranty Term and Gratis Warranty Range**

If any faults or defects (hereinafter "Failure") found to be the responsibility of Mitsubishi occurs during use of the product within the gratis warranty term, the product shall be repaired at no cost via the sales representative or Mitsubishi Service Company.

However, if repairs are required onsite at domestic or overseas location, expenses to send an engineer will be solely at the customer's discretion. Mitsubishi shall not be held responsible for any re-commissioning, maintenance, or testing on-site that involves replacement of the failed module.

[Gratis Warranty Term]

The gratis warranty term of the product shall be for one year after the date of purchase or delivery to a designated place. Note that after manufacture and shipment from Mitsubishi, the maximum distribution period shall be six (6) months, and the longest gratis warranty term after manufacturing shall be eighteen (18) months. The gratis warranty term of repair parts shall not exceed the gratis warranty term before repairs.

[Gratis Warranty Range]

- (1) The range shall be limited to normal use within the usage state, usage methods and usage environment, etc., which follow the conditions and precautions, etc., given in the instruction manual, user's manual and caution labels on the product.
- (2) Even within the gratis warranty term, repairs shall be charged for in the following cases.
  1. Failure occurring from inappropriate storage or handling, carelessness or negligence by the user. Failure caused by the user's hardware or software design.
  2. Failure caused by unapproved modifications, etc., to the product by the user.
  3. When the Mitsubishi product is assembled into a user's device, Failure that could have been avoided if functions or structures, judged as necessary in the legal safety measures the user's device is subject to or as necessary by industry standards, had been provided.
  4. Failure that could have been avoided if consumable parts (battery, backlight, fuse, etc.) designated in the instruction manual had been correctly serviced or replaced.
  5. Failure caused by external irresistible forces such as fires or abnormal voltages, and Failure caused by force majeure such as earthquakes, lightning, wind and water damage.
  6. Failure caused by reasons unpredictable by scientific technology standards at time of shipment from Mitsubishi.
  7. Any other failure found not to be the responsibility of Mitsubishi or that admitted not to be so by the user.

## **2. Onerous repair term after discontinuation of production**

- (1) Mitsubishi shall accept onerous product repairs for seven (7) years after production of the product is discontinued. Discontinuation of production shall be notified with Mitsubishi Technical Bulletins, etc.
- (2) Product supply (including repair parts) is not available after production is discontinued.

## **3. Overseas service**

Overseas, repairs shall be accepted by Mitsubishi's local overseas FA Center. Note that the repair conditions at each FA Center may differ.

## **4. Exclusion of loss in opportunity and secondary loss from warranty liability**

Regardless of the gratis warranty term, Mitsubishi shall not be liable for compensation to:

- (1) Damages caused by any cause found not to be the responsibility of Mitsubishi.
- (2) Loss in opportunity, lost profits incurred to the user by Failures of Mitsubishi products.
- (3) Special damages and secondary damages whether foreseeable or not, compensation for accidents, and compensation for damages to products other than Mitsubishi products.
- (4) Replacement by the user, maintenance of on-site equipment, start-up test run and other tasks.

## **5. Changes in product specifications**

The specifications given in the catalogs, manuals or technical documents are subject to change without prior notice.

# TRADEMARKS

---

The company names, system names and product names mentioned in this manual are either registered trademarks or trademarks of their respective companies.

In some cases, trademark symbols such as '™' or '®' are not specified in this manual.





SH(NA)-081684ENG-E(1910)MEE

MODEL: CCIEFB-R-E

MODEL CODE: 13JX62

## **MITSUBISHI ELECTRIC CORPORATION**

HEAD OFFICE : TOKYO BUILDING, 2-7-3 MARUNOUCHI, CHIYODA-KU, TOKYO 100-8310, JAPAN  
NAGOYA WORKS : 1-14, YADA-MINAMI 5-CHOME, HIGASHI-KU, NAGOYA, JAPAN

When exported from Japan, this manual does not require application to the  
Ministry of Economy, Trade and Industry for service transaction permission.

Specifications subject to change without notice.